

POS-3120

Quick Reference Guide



Manual ver Q2

All Right Reserved Copyright 2011

Packing Checklist

If you discover any item below was damaged or lost, please contact your vendor.

- POS-3120 X 1
- This Quick Reference Guide X 1
- AC Power Adaptor X 1
- Driver CD X 1

Specifications

System	
CPU Support	Intel® ATOM Pineview D525 CPU
Memory Support	2 x DDR3 SO-DIMM Slot, 1GB DDR3 SO-DIMM (up to 4GB)
Core Logic	Intel® ICH8M
Network	10/100/1000 Base-T Fast Ethernet
Power Supply	120 Watt power adapter
System Weight	4.5 kg
Dimension (WxHxD)	300 x 299 x 135 mm (11.81" x 11.77" x 5.31")
O.S. Support	Windows XP/ XPE, WEPOS, POSReady 2009
Storage	
HDD	1 x 2.5" SATA HDD
CF	Bootable Compact Flash slot for CF type I/II storage
I/O Ports	
USB	4 x USB 2.0 port/ 1 x USB 2.0 on side bezel
Serial Port	3 x DB-9 (COM 1/2/4), 1 x RJ45 (COM 3), +5V/12V selectable (COM1 ~ COM3)
PS/2	1 x PS/2 ports (default at keyboard)
LAN	1 x 10/100/1000 Mbps
VGA	1 x DB-15 VGA interface
Audio	1 x 2W speaker
Cash Drawer	1 x RJ11 Cash Drawer port (12V/24V)
Printer	2" or 3" easy loading thermal printer with auto cutter
Display	
LCD	10.4" TFT LCD
Max. Resolution	1024 x 768 / 800 x 600
Brightness	300/230 cd/m ²
Touch Screen	5-wire analog resistive
Viewing Angle	+70° ~ -70° horizontal, +60° ~ -60° vertical
Environment	
EMC & Safety	CE, FCC
Operating Temp.	0 °C~ 35 °C
Storage Temp.	-20 °C ~ 60 °C
Humidity	20% ~ 90%

System View

Front View

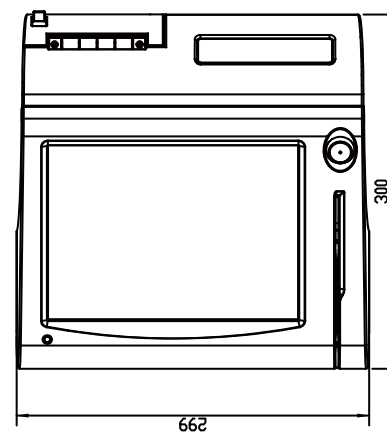

Side View

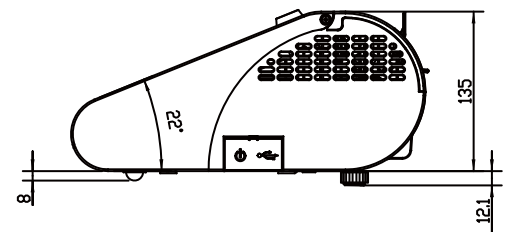

Top View

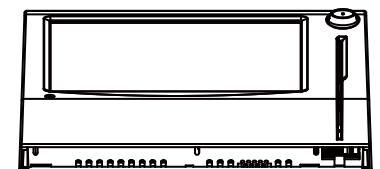

Bottom View

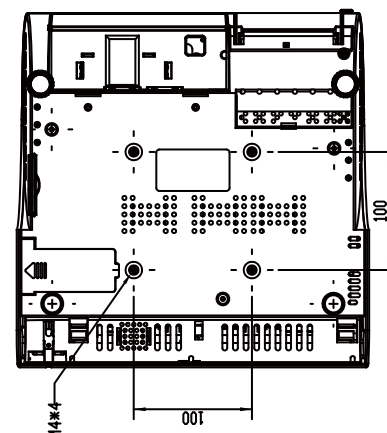

Rear View

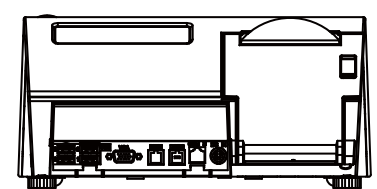

Quarter View

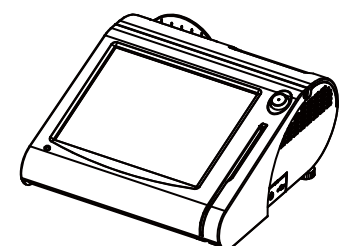

Unit: mm

POS-3120

The One-of-a-kind Highly Integrated 10.4" POS Terminal

Easy Maintenance

HDD Maintenance

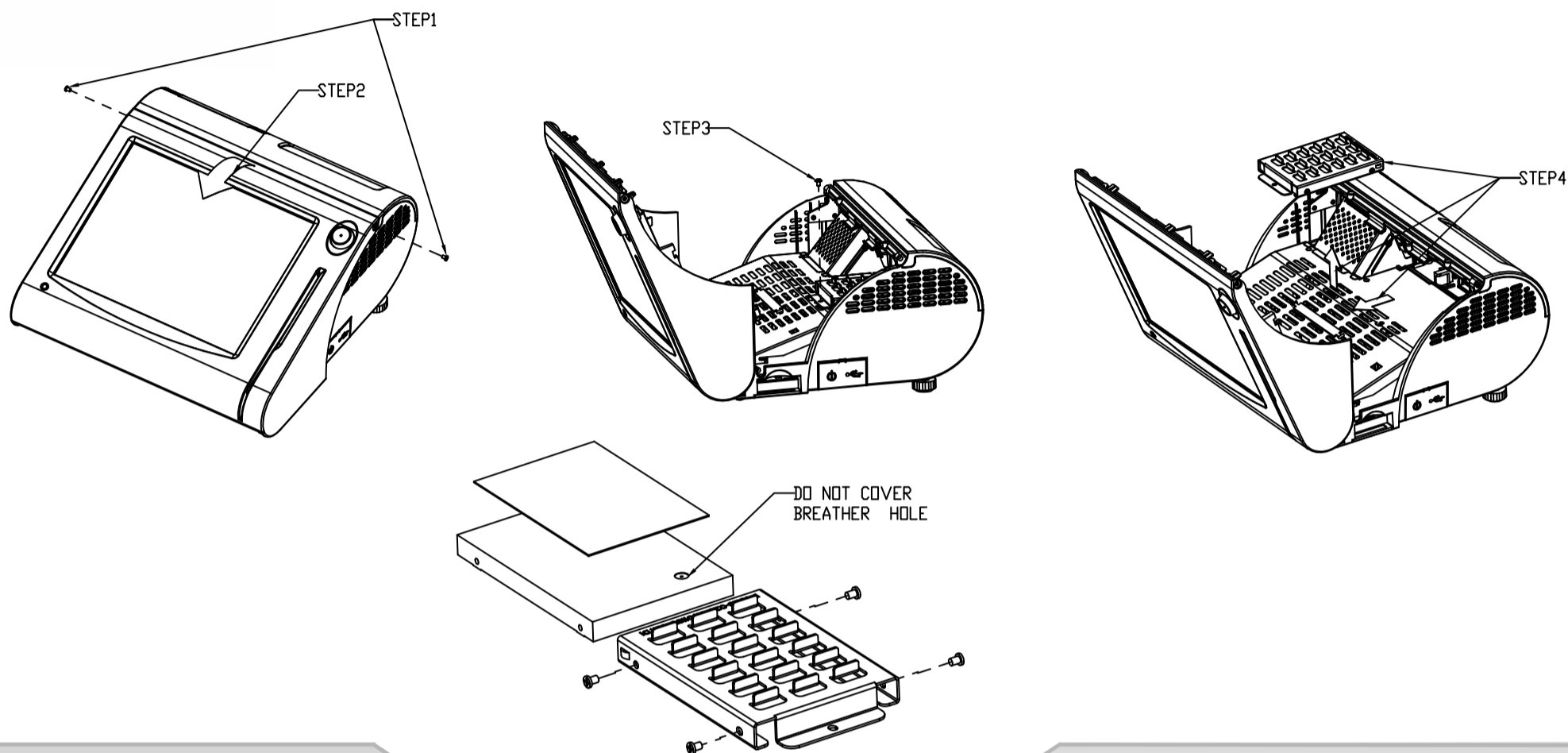

Jumper Setting

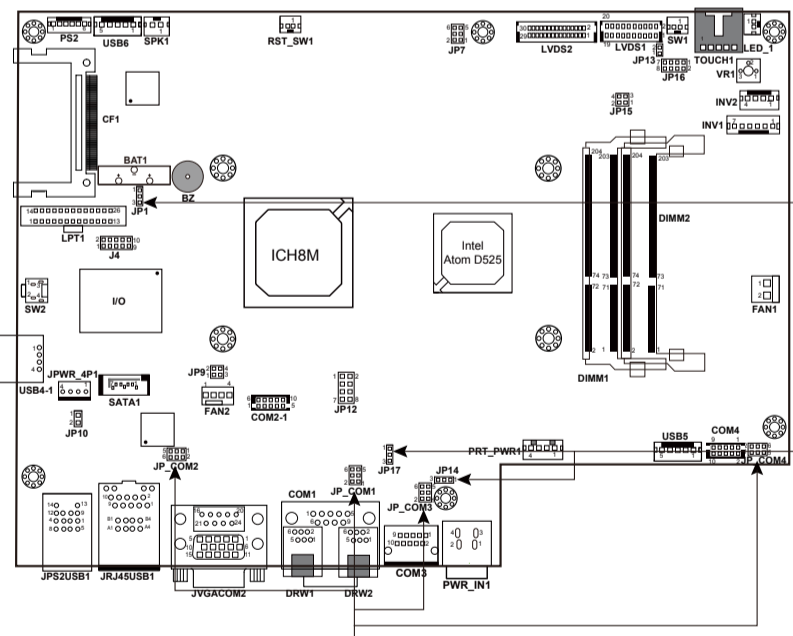

Clear CMOS Date Selection

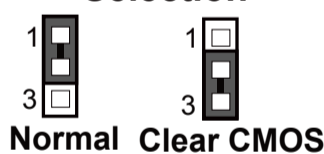

Cash Drawer Power Selection

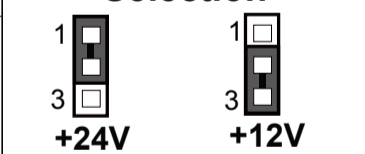

COM Port RI & Voltage Selection

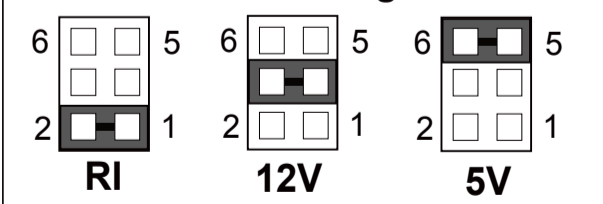

Safety Precaution

The following messages are safety reminders on how to protect your systems from damages, and extending a life cycle of the system.

1. Check the Line Voltage

- Make sure the operating range is between 100V and 240V AC; otherwise, the system could be damaged.

2. Environmental Conditions

- Place your POS-3120 on a sturdy, level surface. Be sure to allow enough space around the system to have easy access needs.
- Avoid installing the system in extremely hot or cold places.
- Avoid exposure to sunlight for a long period of time or in an airtight room.
- Also, avoid the system from any heating device or using the POS-3120 when it has been left outdoors in a cold winter day.
- Bear in mind that the operating ambient temperature is between 0°C and 35°C (32°F~95°F).
- Avoid moving the system rapidly from a hot place to a cold place, and vice versa, because condensation may occur inside the system.
- Operate the POS-3120 in strong vibration may cause hard disk failure.
- Do not place the system too close to any radio-active device. Radio-active device may cause signal interference.

3. Handling

- Avoid placing heavy objects on the top of the system.
- Do not turn the system upside down. This may cause the hard drive to malfunction.
- Do not allow any objects to fall into this product.
- If water or other liquid spills into this product, unplug the power cord immediately.

4. Good Care

- When the outside case gets stained, remove the stains using neutral washing agent with a dry cloth.
- Never use strong agents such as benzene and thinner to clean the surface of the case.
- If heavy stains are present, moisten a cloth with diluted neutral washing agent or alcohol and then wipe thoroughly with a dry cloth.
- If dust is accumulated on the case surface, remove it using a special vacuum cleaner for computers.
- Do not replace the motherboard battery by yourself, or serious damage may occur.

POS-3120

Quick Reference Guide



Manual ver Q3

All Rights Reserved. Copyright 2014

Packing Checklist

If you discover any item below was damaged or lost, please contact your vendor.

- POS-3120 X 1
- This Quick Reference Guide X 1
- AC Power Adaptor X 1
- Driver CD X 1

Specifications

System	
CPU Support	Intel® ATOM Pineview D525 CPU
Memory Support	2 x DDR3 SO-DIMM Slot, 1GB DDR3 SO-DIMM (up to 4GB)
Core Logic	Intel® ICH8M
Network	10/100/1000 Base-T Fast Ethernet
Power Supply	120 Watt power adapter
System Weight	4.5 kg
Dimension (WxHxD)	300 x 299 x 135 mm (11.81" x 11.77" x 5.31")
O.S. Support	Windows XP/ XPE, WEPOS, POSReady 2009
Storage	
HDD	1 x 2.5" SATA HDD
CF	Bootable Compact Flash slot for CF type I/II storage
I/O Ports	
USB	4 x USB 2.0 port/ 1 x USB 2.0 on side bezel
Serial Port	3 x DB-9 (COM 1/2/4), 1 x RJ45 (COM 3), +5V/12V selectable (COM1 ~ COM3)
PS/2	1 x PS/2 ports (default at keyboard)
LAN	1 x 10/100/1000 Mbps
VGA	1 x DB-15 VGA interface
Audio	1 x 2W speaker
Cash Drawer	1 x RJ11 Cash Drawer port (12V/24V)
Printer	2" or 3" easy loading thermal printer with auto cutter
Display	
LCD	10.4" TFT LCD
Max. Resolution	1024 x 768 / 800 x 600
Brightness	300/230 cd/m ²
Touch Screen	5-wire analog resistive
Viewing Angle	+70° ~ -70° horizontal, +60° ~ -60° vertical
Environment	
EMC & Safety	CE, FCC
Operating Temp.	0 °C ~ 35 °C
Storage Temp.	-20 °C ~ 60 °C
Humidity	20% ~ 90%

System View

Front View

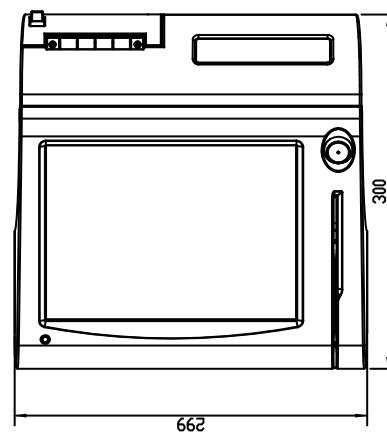

Side View

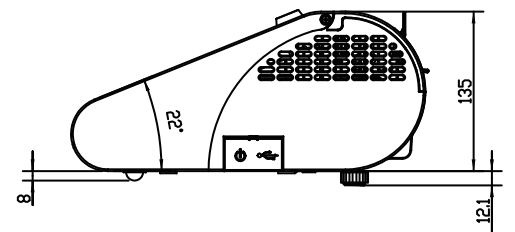

Top View

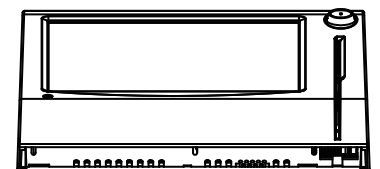

Bottom View

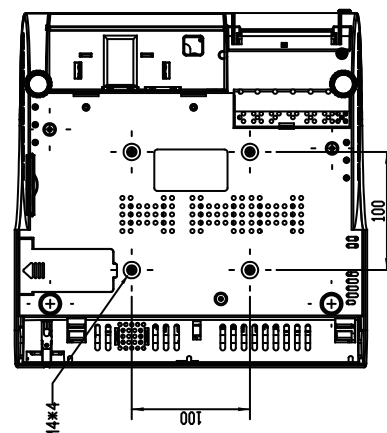

Rear View

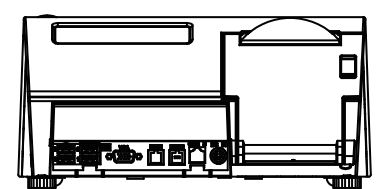

Quarter View

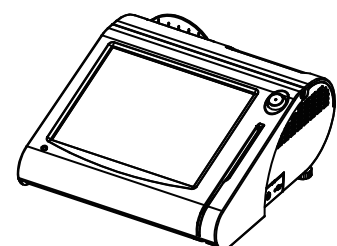

Unit: mm

POS-3120

The One-of-a-kind Highly Integrated 10.4" POS Terminal

Easy Maintenance

HDD Maintenance

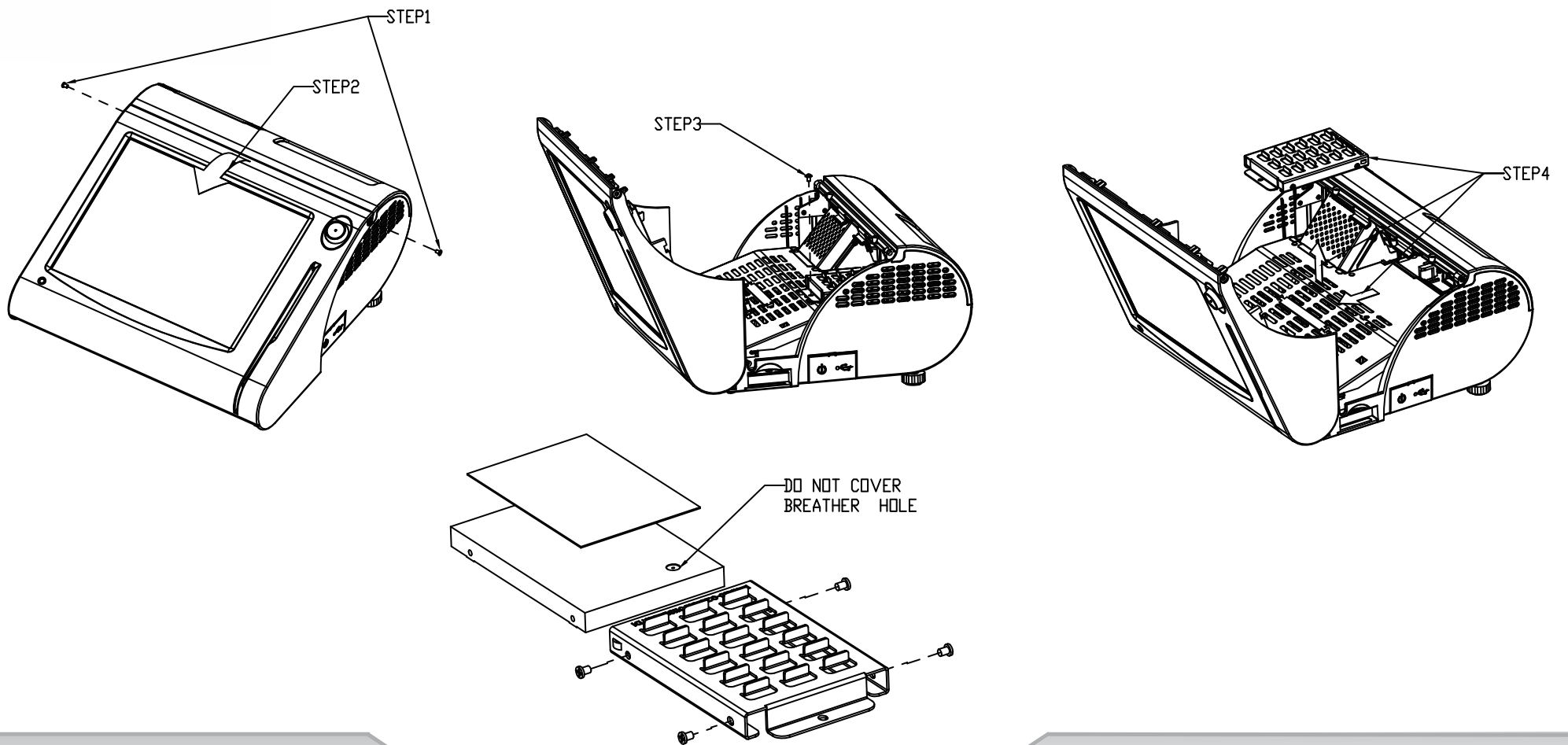

Jumper Setting

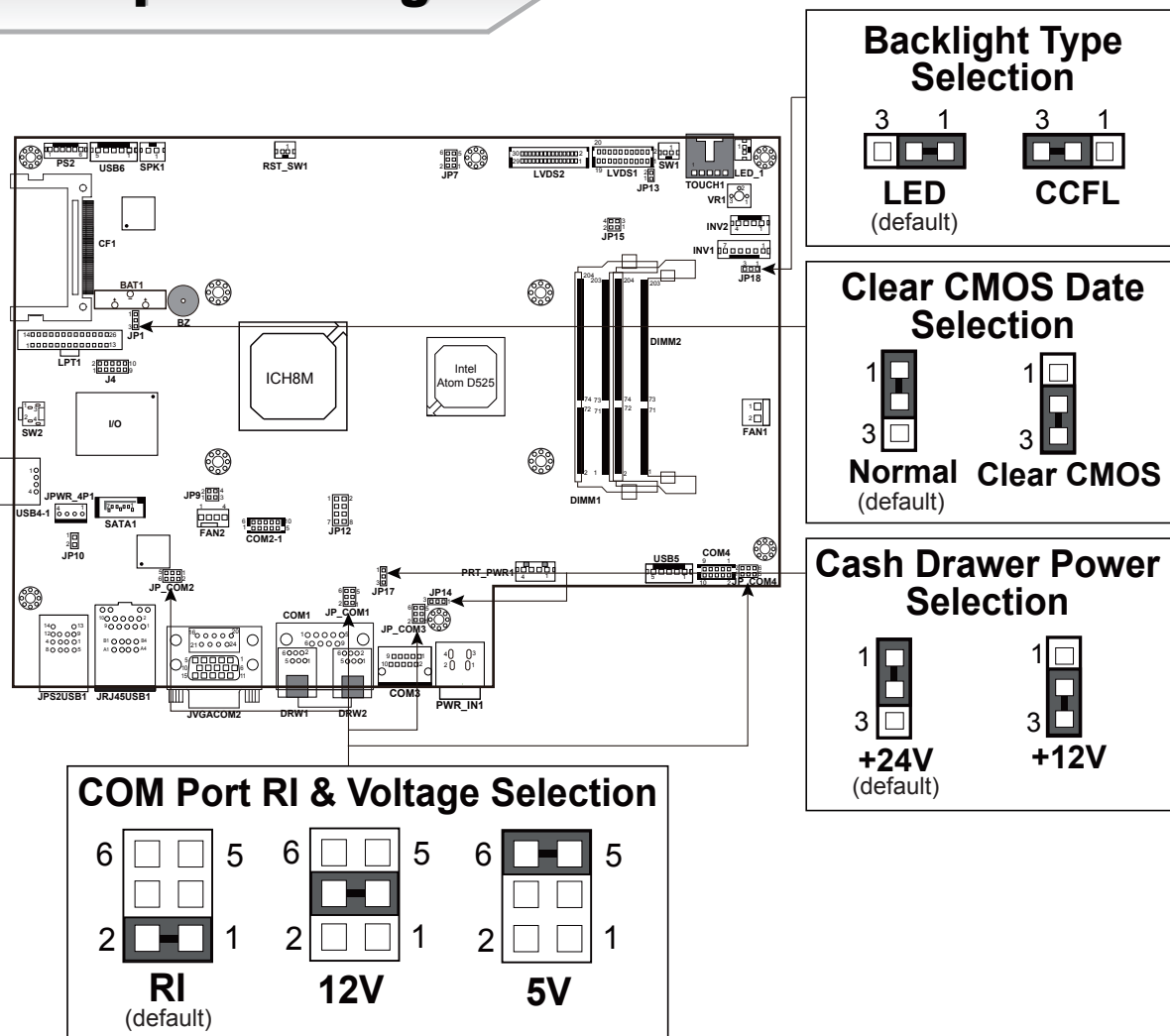

Safety Precaution

The following messages are safety reminders on how to protect your systems from damages, and extending a life cycle of the system.

1. Check the Line Voltage

- Make sure the operating range is between 100V and 240V AC; otherwise, the system could be damaged.

2. Environmental Conditions

- Place your POS-3120 on a sturdy, level surface. Be sure to allow enough space around the system to have easy access needs.
- Avoid installing the system in extremely hot or cold places.
- Avoid exposure to sunlight for a long period of time or in an airtight room.
- Also, avoid the system from any heating device or using the POS-3120 when it has been left outdoors in a cold winter day.
- Bear in mind that the operating ambient temperature is between 0°C and 35°C (32°F~95°F).
- Avoid moving the system rapidly from a hot place to a cold place, and vice versa, because condensation may occur inside the system.
- Operate the POS-3120 in strong vibration may cause hard disk failure.
- Do not place the system too close to any radio-active device. Radio-active device may cause signal interference.

3. Handling

- Avoid placing heavy objects on the top of the system.
- Do not turn the system upside down. This may cause the hard drive to malfunction.
- Do not allow any objects to fall into this product.
- If water or other liquid spills into this product, unplug the power cord immediately.

4. Good Care

- When the outside case gets stained, remove the stains using neutral washing agent with a dry cloth.
- Never use strong agents such as benzene and thinner to clean the surface of the case.
- If heavy stains are present, moisten a cloth with diluted neutral washing agent or alcohol and then wipe thoroughly with a dry cloth.
- If dust is accumulated on the case surface, remove it using a special vacuum cleaner for computers.
- Do not replace the motherboard battery by yourself, or serious damage may occur.