

# **USER MANUAL**

**SG-S151 / SG-S171 /  
SG-S211**

**15" / 17" / 21.5" Intel® Celeron® J3455 /  
Atom® x7-E3950 Processor  
Fanless and All-around IP66/IP69K  
Stainless Panel PC**

**SG-S151 / SG-S171 / SG-S211 M2**

---

---

***SG-S151 / SG-S171 / SG-S211***  
***15"/17"/21.5" Intel<sup>®</sup> Celeron<sup>®</sup> J3455 /***  
***Atom<sup>®</sup> x7-E3950 Processor***  
***Fanless and All-around IP66/IP69K***  
***Stainless Panel PC***

**COPYRIGHT NOTICE & TRADEMARK**

All trademarks and registered trademarks mentioned herein are the property of their respective owners.

This manual is copyrighted in Feb. 2020. You may not reproduce or transmit in any form or by any means, electronic, or mechanical, including photocopying and recording.

**DISCLAIMER**

This user's manual is meant to assist users in installing and setting up the system. The information contained in this document is subject to change without any notice.

**CE NOTICE**

This is a class A product. In a domestic environment this product may cause radio interference in which case the user may be required to take adequate measures.

---

---





---

---

## FCC NOTICE

This equipment has been tested and found to comply with the limits for a Class A digital device, pursuant to part 15 of the FCC Rules. These limits are designed to provide reasonable protection against harmful interference when the equipment is operated in a commercial environment. This equipment generates, uses, and can radiate radio frequency energy and, if not installed and used in accordance with the instruction manual, may cause harmful interference to radio communications. Operation of this equipment in a residential area is likely to cause harmful interference in which case the user will be required to correct the interference at his own expense.

You are cautioned that any change or modifications to the equipment not expressly approve by the party responsible for compliance could void your authority to operate such equipment.

	<b>CAUTION:</b> Danger of explosion may occur when the battery is incorrectly replaced. Replace the battery only with the same or equivalent type recommended by the manufacturer. Dispose of used batteries according to the manufacturer's instructions.
	<b>CAUTION:</b> The waterproof capability of the device may be incapable when the screws are loosened.
	<b>CAUTION:</b> The O-ring to seal the device may be damaged during the maintenance process. Qualified engineer is recommended to make the O-ring replacement to keep the waterproof capability of the device.
	<b>WARNING:</b> Some internal parts of the system may have high electrical voltage. We strongly recommend that only qualified engineers are allowed to service and disassemble the system. If any damages should occur on the system and are caused by unauthorized servicing, it will not be covered by the product warranty.

---

---

# Contents

<b>Revision History .....</b>	<b>v</b>
<b>1 Introduction .....</b>	<b>1-1</b>
1.1 About This Manual .....	1-2
<b>2 Getting Started .....</b>	<b>2-1</b>
2.1 Package List.....	2-2
2.2 System Overview .....	2-3
2.3 SG-S151 System Specifications .....	2-9
2.4 SG-S171 System Specifications .....	2-11
2.5 SG-S211 System Specifications .....	2-13
2.6 Safety Precautions .....	2-15
<b>3 System Configuration.....</b>	<b>3-1</b>
3.1 External I/O Ports Diagram .....	3-2
3.1.1 Rear I/O Ports Diagram .....	3-2
3.2 Jumper & Connector Quick Reference Table.....	3-3
3.3 Component Locations Of System Main Board.....	3-4
3.3.1 Top View of System Main Board .....	3-4
3.3.2 Bottom View of System Main Board.....	3-6
3.4 How To Set Jumpers .....	3-7
3.5 Setting Main Board Connectors and Jumpers .....	3-9
3.5.1 COM3 and COM4 PIN9 Definition Selection Guide .....	3-9
3.5.2 COM Connectors (COM1, COM2) .....	3-10
3.5.3 LAN1, LAN2 Ports (LAN1, LAN2).....	3-11
3.5.4 Dual USB 3.0 Connectors (USB1) .....	3-13
3.5.5 USB 3.0 Connectors (USB2).....	3-13
3.5.6 USB 2.0 Connector (USB3).....	3-14

---

3.5.7	Programmable GPIO Pin Header (JDIO1) .....	3-14
3.5.8	I2C Wafer (JI2C1).....	3-15
3.5.9	MCU FW Rewrite Connector (JMCU1) .....	3-15
3.5.10	DC Power Input Connector (PWR2).....	3-15
3.5.11	Sysetm Fan Connector (FAN1) .....	3-16
3.5.12	MINI PCI Express Slot (M_PCIE1).....	3-17
3.5.13	LVDS Connector (LVDS1) .....	3-18
3.5.14	Slide Switch For LVDS Resolution Selection (SW1) .....	3-19
3.5.15	Front Panel Connector (JFP1) .....	3-22
3.5.16	HD Audio Connector (AUDIO1).....	3-22
3.5.17	Panel Inverter Connector (JINV1) .....	3-23
3.5.18	Serial ATA (SATA) 3.0 Connector (SATA1).....	3-23
3.5.19	SATA Power Connector (SATA_PWR1) .....	3-23
3.5.20	BIOS Reset Connector (JP9) .....	3-24
3.5.21	LVDS Backlight Control Selection (JP7).....	3-24
3.5.22	LVDS VCC Voltage Selection (JP_VDD1).....	3-25
3.5.23	Clear CMOS Data Selection (JP4) .....	3-26
3.6	External M12 Waterproof Connectors.....	3-27
3.6.1	USB 2.0 Connectors .....	3-27
3.6.2	Power Button .....	3-27
3.6.3	LAN1, LAN2 Ports .....	3-28
3.6.4	COM Connector.....	3-29
3.6.5	DC Power Input Connector .....	3-29
<b>4</b>	<b>Software Utilities .....</b>	<b>4-1</b>
4.1	Introduction.....	4-2
4.2	Installing Intel® Chipset Software Installation Utility.....	4-3
4.3	Installing Intel® Trusted Execution Engine Installation Utility ....	4-4

---

4.4	Installing Microsoft Hotfix kb3211320 and kb3213986 Driver ...	4-5
4.5	Installing Graphics Driver Utility .....	4-6
4.6	Installing LAN Driver Utility.....	4-7
4.7	Installing Sound Driver Utility .....	4-8
4.8	Installing Intel® Serial I/O Driver Utility .....	4-9
<b>5</b>	<b>BIOS SETUP .....</b>	<b>5-1</b>
5.1	Introduction.....	5-2
5.2	Accessing Setup Utility.....	5-4
5.3	Main.....	5-7
5.4	Advanced .....	5-9
5.4.1	Advanced - ACPI Settings .....	5-10
5.4.2	Advanced – Onboard Device Configuration .....	5-11
5.4.3	Advanced – Hardware Monitor.....	5-12
5.4.4	Advanced – F81964 Watchdog Configuration.....	5-13
5.4.5	Advanced – S5 RTC Wake Settings.....	5-14
5.4.5.1	S5 RTC Wake Settings [Fixed Time].....	5-15
5.4.5.2	S5 RTC Wake Settings [Dynamic Time].....	5-16
5.4.6	Advanced – CPU Configuration .....	5-17
5.4.6.1	Socket 0 CPU Information .....	5-18
5.4.6.2	CPU Power Management Configuration .....	5-19
5.4.7	Advanced – F81964 Super IO Configuration .....	5-20
5.4.8	Advanced – USB Configuration.....	5-22
5.4.9	Chipset .....	5-23
5.4.9.1	Chipset – North Bridge .....	5-24
5.4.9.2	Chipset – South Bridge .....	5-25
5.4.9.3	Chipset – South Bridge – PCI Express Configuration.....	5-26
5.4.9.4	Chipset – South Bridge – SATA Drives .....	5-30

---

5.4.9.5 Chipset – South Bridge – Miscellaneous Configuration ..	5-31
5.5 Security .....	5-32
5.6 Boot .....	5-34
5.7 Save & Exit.....	5-36
<b>Appendix A System Diagrams .....</b>	<b>A-1</b>
SG-S151 System Exploded Diagram .....	A-2
SG-S171 System Exploded Diagram .....	A-4
SG-S211 System Exploded Diagram .....	A-6
VESA Mount Installation Exploded Diagram .....	A-8
Stand Kit Installation Exploded Diagram .....	A-9
SG-S151 Packing Exploded Diagram .....	A-10
SG-S171 Packing Exploded Diagram .....	A-11
SG-S211 Packing Exploded Diagram.....	A-12
<b>Appendix B Technical Summary .....</b>	<b>B-1</b>
BE-0986 Block Diagram .....	B-2
Interrupt Map .....	B-3
I/O MAP .....	B-16
Memory Map.....	B-18
Configuring WatchDog Timer .....	B-20
Flash BIOS Update.....	B-22

---

---

## Revision History

The revision history of SG-S151/SG-S171/SG-S211 User Manual is described below:

Version No.	Revision History	Date
M2	Added user manual information for SG-S171 and SG-S211.	2020/02/04
M1	Initial Release	2019/07/01



# 1

## Introduction

---

---

This chapter provides the introduction for SG-S151 / SG-S171 / SG-S211 system as well as the framework of the user manual.

The following topic is included:

- About This Manual

## **1.1 About This Manual**

Thank you for purchasing our SG-S151 / SG-S171 / SG-S211 system. The SG-S151 / SG-S171 / SG-S211 is an updated system designed to be comparable with the highest performance of IBM AT personal computers. The SG-S151 / SG-S171 / SG-S211 provides faster processing speed, greater expandability and can handle more tasks than before. This manual is designed to assist you how to install and set up the whole system. It contains 5 chapters and 2 appendixes. Users can configure the system according to their own needs. This user manual is intended for service personnel with strong hardware background. It is not intended for general users.

The following section describes the structure of this user manual.

### ***Chapter 1 Introduction***

This chapter introduces the framework of this user manual.

### ***Chapter 2 Getting Started***

This chapter describes the package contents and system specifications, and illustrates the physical appearances for SG-S151/SG-S171/SG-S211 system. Read the safety reminders carefully on how to take care of your system properly.

### ***Chapter 3 System Configuration***

This chapter describes the locations and functions of the system motherboard components. You will learn how to properly configure the connectors and system configuration jumpers on the motherboard and configure the system to meet your own needs.

### ***Chapter 4 Software Utilities***

This chapter contains helpful information for proper installations of the Intel Chipset Software Installation Utility, Intel Trusted Execution Engine Driver Utility, Graphics Driver Utility, LAN Driver Utility, Microsoft Hotfix Driver Utility, Sound Driver Utility and Intel Serial I/O Driver Utility.

### ***Chapter 5 AMI BIOS Setup***

This chapter provides BIOS setup information.

### ***Appendix A System Assembly Diagrams***

This appendix provides the exploded diagrams and part numbers of SG-S151 / SG-S171 / SG-S211.

### ***Appendix B Technical Summary***

This appendix provides the information about the system block diagram, allocation maps for system resources, Watchdog Timer Configuration and Flash BIOS Update.

# 2 Getting Started

---

---

This chapter provides the information for SG-S151 / SG-S171 / SG-S211 system. It describes how to set up the system quickly and outlines the system specifications.

The following topics are included:

- Package List
- System Overview
- System Specification
- Safety Precautions

**Experienced users can go to Chapter 3 System Configuration on page 3-1 for a quick start.**

## **2.1 Package List**

If you discover any of the items listed below are damaged or lost, please contact your local distributor immediately.

<b>Item</b>	<b>Q'ty</b>
SG-S151 / SG-S171 / SG-S211	1
Manual / Driver DVD	1
Quick Guide	1
M12 Power Supply Cable	1
U Stand (optional)	1

## 2.2 System Overview

**SG-S151**

Unit: mm

Front View

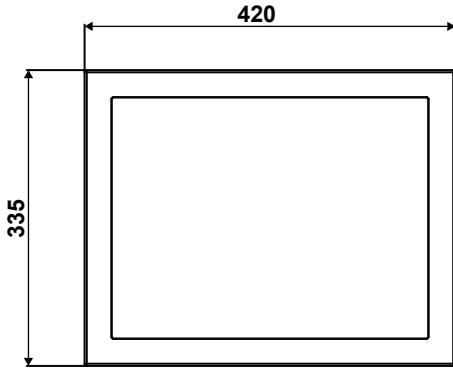

Rear View

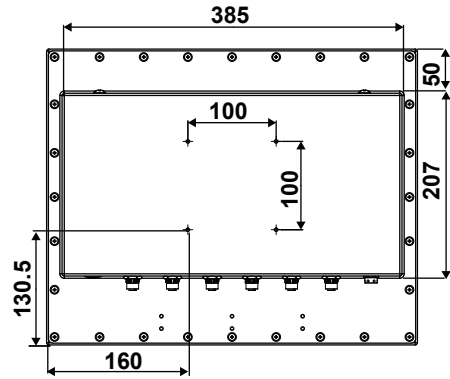

Top View

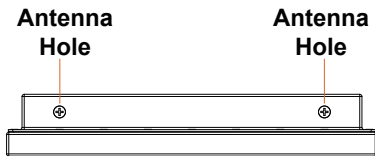

Bottom View

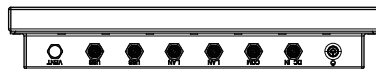

Left Side View

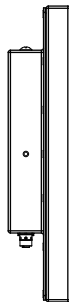

Right Side View



**Quarter View**

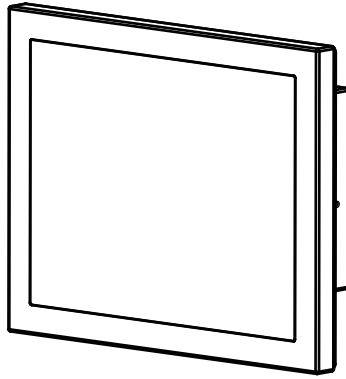

**SG-S171**

Unit: mm

**Front View**

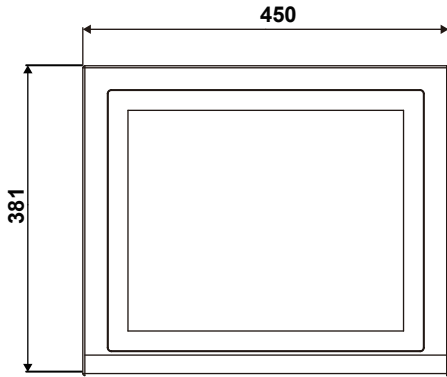

**Rear View**

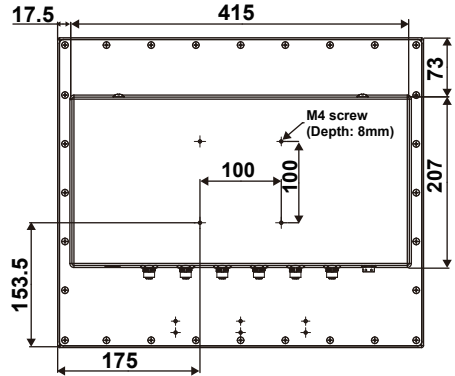

**Top View**



**Bottom View**

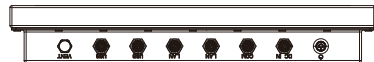

**Left Side View**



**Right Side View**



**Quarter View**

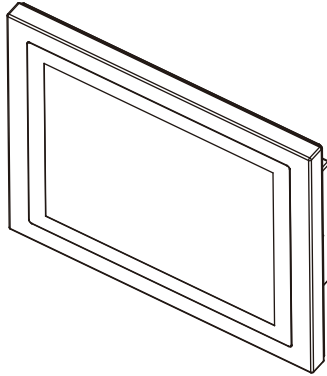



**SG-S211**

Unit: mm

**Front View**

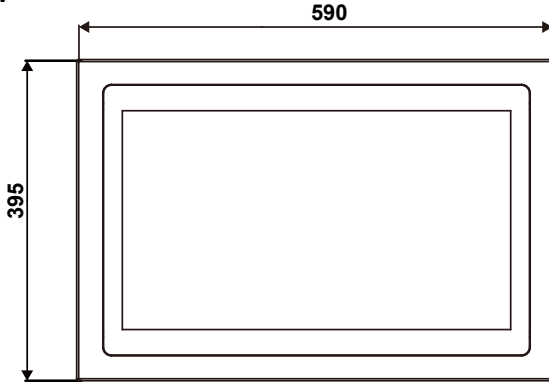

**Rear View**

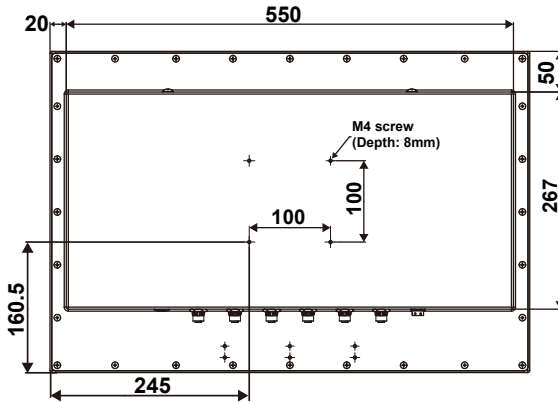

**Top View**

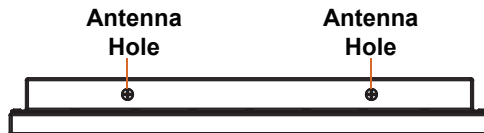

**Bottom View**



**Left Side View**



**Right Side View**



**Quarter View**

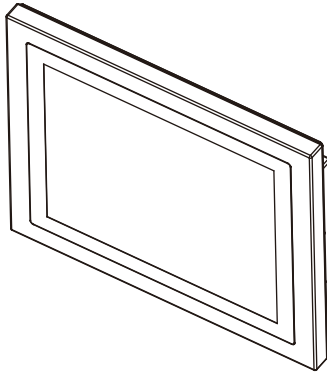

## 2.3 SG-S151 System Specifications

<b>System</b>	
CPU Type	<ul style="list-style-type: none"> <li>➤ Intel® Celeron® J3455</li> <li>➤ Intel® Atom® x7 E3950</li> </ul>
Memory Support	➤ 1 x DDR3L 1600/1867MHz SO-DIMM socket (up to 8GB) (non-ECC)
Operating System	<ul style="list-style-type: none"> <li>➤ Windows® 10 IoT LTSC 2019</li> <li>➤ Ubuntu 16.04</li> </ul>
Enclosure	➤ Stainless SUS304/SUS316
IP Rating	➤ IP66/IP69K
Power Input	➤ DC In 12V/24V
Mounting Support	➤ Wall Mount / VESA 100 / Table Stand
Watchdog	➤ 1~255 second Watchdog timer selectable
BIOS	➤ AMI SPI BIOS
Net Weight	➤ 7.5kg
Dimensions (W x H x D)	➤ 420 x 335 x 70mm
Certifications	➤ FCC / CE
<b>I/O Ports</b>	
Power Input	<ul style="list-style-type: none"> <li>➤ 1 x M12 Waterproof Connector with Remote Switch</li> <li>➤ Supports 12V, 16~24V DC</li> </ul>
Serial Port	<ul style="list-style-type: none"> <li>➤ 1 x COM port with M12 waterproof connector</li> <li>➤ COM1 for RS-232/422/485 selectable under BIOS</li> </ul>
LAN	<ul style="list-style-type: none"> <li>➤ 2 x GbE LANs with M12 waterproof connector</li> <li>LAN 1: Intel® I210IT</li> <li>LAN 2 : Intel® I210IT</li> <li>➤ Supports Wake-On-LAN</li> </ul>
USB	➤ 2 x USB 2.0 with M12 waterproof connectors
Storage	➤ 1 x 2.5" SATA III HDD or SSD
Expansion Slot	➤ 1 x full-sized Mini PCIe slot (Mini PCIe and USB signals)
<b>Display</b>	
LCD	➤ 15" TFT LCD (LED) XGA (resolution 1024 x 768), 450 nits
Touchscreen	<ul style="list-style-type: none"> <li>➤ 15" Projected capacitive touchscreen (USB interface)</li> <li>➤ 15" 5-wire resistive touchscreen (USB interface)</li> </ul>

<b>Environment</b>	
Operating Temperature (with airflow)	➤ HDD: 0°C ~ 40°C (32°F ~ 104°F)
	➤ SSD: 0°C ~ 50°C (32°F ~ 122°F)
	➤ Wide Temperature SSD: -20°C ~ 50°C (-4°F ~ 122°F) SSD (for x7-E3950 only)
Storage Temperature	➤ -20°C ~ 80°C (-4°F ~ 176°F)
Humidity	➤ 20%~ 90%

## 2.4 SG-S171 System Specifications

<b>System</b>	
CPU Type	<ul style="list-style-type: none"> <li>➤ Intel® Celeron® J3455 processor</li> <li>➤ Intel® Atom® x7 E3950 processor</li> </ul>
Memory Support	➤ 1 x DDR3L 1600/1867MHz SO-DIMM socket (up to 8GB) (non-ECC)
Operating System	<ul style="list-style-type: none"> <li>➤ Windows® 10 IoT LTSC 2019</li> <li>➤ Ubuntu 16.04</li> </ul>
Enclosure	➤ Stainless SUS304/SUS316
IP Rating	➤ IP66/IP69K
Power Input	➤ DC In 12V/24V
Watchdog	➤ 1~255 second watchdog timer selectable
Mounting Support	➤ Wall Mount / VESA 100 / Table Stand
BIOS	➤ AMI SPI BIOS
System Weight	➤ 8.5kg
Dimensions (W x H x D)	➤ 450 x 381 x 70mm
Certificate	➤ FCC / CE
<b>I/O Ports</b>	
Power Input	<ul style="list-style-type: none"> <li>➤ 1 x M12 Waterproof Connector with Remote Switch</li> <li>➤ Supports 12V / 16~24V DC</li> </ul>
Serial Port	<ul style="list-style-type: none"> <li>➤ 1 x COM port with M12 waterproof connector</li> <li>➤ COM1 for RS-232/422/485 selectable under BIOS</li> </ul>
LAN	<ul style="list-style-type: none"> <li>➤ 2 x GbE LANs with M12 waterproof connectors</li> <li>LAN 1: Intel® I210IT</li> <li>LAN 2 : Intel® I210IT</li> <li>➤ Supports Wake-On-LAN</li> </ul>
USB	➤ 2 x USB 2.0 with M12 waterproof connectors
Storage	➤ 1 x 2.5" SATA III HDD or SSD
Expansion Slot	➤ 1 x full-sized Mini PCIe slot (Mini PCIe and USB signals)
<b>Display</b>	
LCD	➤ 17" TFT LCD (LED) XGA (resolution 1280 x 1024), 350 nits
Touchscreen	<ul style="list-style-type: none"> <li>➤ 17" Projected capacitive touchscreen (USB interface)</li> <li>➤ 17" 5-wire resistive touchscreen (USB interface)</li> </ul>

<b>Environment</b>	
Operating Temperature (with airflow)	➤ HDD: 0°C ~ 40°C (32°F ~ 104°F)
	➤ SSD: 0°C ~ 50°C (32°F ~ 122°F)
	➤ Wide Temperature SSD: -20°C ~ 50°C (-4°F ~ 122°F) SSD (for x7-E3950 only)
Storage Temperature	➤ -20°C ~ 80°C (-4°F ~ 176°F)
Humidity	➤ 20%~ 90%

## 2.5 SG-S211 System Specifications

<b>System</b>	
CPU Type	➤ Intel® Celeron® J3455 processor
Memory Support	➤ 1 x DDR3L 1600/1867MHz SO-DIMM socket (up to 8GB) (non-ECC)
Operating System	➤ Windows® 10 IoT LTSC 2019 ➤ Ubuntu 16.04
Enclosure	➤ Stainless SUS304/SUS316
IP Rating	➤ IP66/IP69K
Power Input	➤ DC In 12V/24V
Watchdog	➤ 1~255 second watchdog timer selectable
Mounting Support	➤ Wall Mount / VESA 100 / Table Stand
BIOS	➤ AMI SPI BIOS
System Weight	➤ 9.5kg
Dimensions (W x H x D)	➤ 590 x 395 x 70mm
Certificate	➤ FCC / CE
<b>I/O Ports</b>	
Power Input	➤ 1 x M12 Waterproof Connector with Remote Switch ➤ Supports 12V / 16~24V DC
Serial Port	➤ 1 x COM port with M12 waterproof connector ➤ COM1 for RS-232/422/485 selectable under BIOS
LAN	➤ 2 x GbE LANs with M12 waterproof connectors LAN 1: Intel® I210IT LAN 2: Intel® I210IT ➤ Supports Wake-On-LAN
USB	➤ 2 x USB 2.0 with M12 waterproof connector
Storage	➤ 1 x 2.5" SATA III HDD or SSD
Expansion Slot	➤ 1 x full-sized Mini PCIe slot (Mini PCIe and USB signals)
<b>Display</b>	
LCD	➤ 21.5" TFT LCD (LED) FHD (resolution 1920 x 1080), 350 nits
Touchscreen	➤ Projected capacitive touchscreen (USB interface) ➤ 5-wire resistive touchscreen (USB interface)

<b>Environment</b>	
Operating Temperature (with airflow)	➤ HDD: 0°C ~ 40°C (32°F ~ 104°F) ➤ SSD: 0°C ~ 50°C (32°F ~ 122°F)
Storage Temperature	➤ -20°C ~ 80°C (-4°F ~ 176°F)
Humidity	➤ 20%~ 90%



## **2.6 Safety Precautions**

Before operating this system, read the following information carefully to protect your systems from damages, and extend the life cycle of the system.

### **1. Check the Line Voltage**

- The operating voltage for the power supply should be DC In 12V/24V; otherwise, the system may be damaged.

### **2. Environmental Conditions**

- Place your SG-S151 / SG-S171 / SG-S211 on a sturdy, level surface. Be sure to allow enough space around the system to have easy access needs.
- Avoid installing your SG-S151 / SG-S171 / SG-S211 system in extremely hot or cold places.
- Avoid direct sunlight exposure for a long period of time (for example, in a closed car in summer time. Also avoid the system from any heating device.). Or do not use SG-S151 / SG-S171 / SG-S211 when it has been left outdoors in a cold winter day.
- Avoid moving the system rapidly from a hot place to a cold place, and vice versa, because condensation may occur inside the system.
- Protect your SG-S151 / SG-S171 / SG-S211 from strong vibrations which may cause hard disk failure.
- Always shut down the operating system before turning off the power.
- Do not place the system too close to any radio-active device. Radio-active device may cause signal interference.

### **3. Handling**

- Avoid placing heavy objects on the top of the system.
- Do not turn the system upside down. This may cause the hard drive to malfunction.
- Do not allow any objects to fall into this device.

### **4. Good Care**

- When the outside case gets stained, remove the stains using neutral washing agent with a dry cloth.
- Never use strong agents such as benzene and thinner to clean the surface of the case.
- If heavy stains are present, moisten a cloth with diluted neutral washing agent or alcohol and then wipe thoroughly with a dry cloth.
- If dust is accumulated on the case surface, remove it by using a special vacuum cleaner for computers.

# 3

## System Configuration

---

---

This chapter contains helpful information about the jumper & connector settings, and component locations for the main board.

The following topics are included:

- External I/O Ports Diagram
- Connector & Jumper Quick Reference Table
- System Main Board Component Locations
- How to Set Jumpers
- Setting Main Board Connectors and Jumpers
- External M12 waterproof Connectors

### 3.1 External I/O Ports Diagram

#### 3.1.1 Rear I/O Ports Diagram

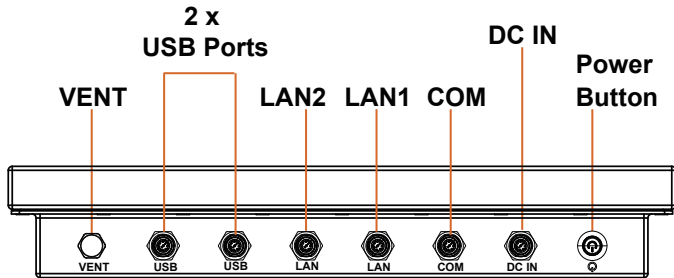

### 3.2 Jumper & Connector Quick Reference Table

<b>JUMPER Description</b>	<b>NAME</b>
COM3 Pin9 RI/5V/12V Selection	JP_COM3
COM4 Pin9 RI/5V/12V Selection	JP_COM4
LVDS VCC Voltage Selection	JP_VDD1
Clear CMOS Data Selection	JP4
LVDS Backlight Control Selection	JP7
Slide Switch for LVDS Resolution Selection	SW1

<b>CONNECTOR Description</b>	<b>NAME</b>
COM Connector	COM1, COM2
2 x LAN Ports (Rear)	LAN1, LAN2
2 x Dual USB 3.0 Ports (Rear)	USB1, USB2
2 x USB 2.0 Ports (Internal)	USB3
Programmable GPIO Pin Header	JDIO1
I2C Wafer	JI2C1
MCU FW Rewrite Connector	JMCU1
System Fan Connector	FAN1
DC Power Input Connector	PWR2
Mini PCI Express Slot	M_PCIE1
LVDS Connector	LVDS1
Front Panel Connector	JFP1
HD Audio Connector	AUDIO1
Panel Inverter Connector	JINV1
SATA 3.0 Connector	SATA1
SATA Power Connector	SATA_PWR1
BIOS Reset Connector	JP9

### 3.3 Component Locations Of System Main Board

#### 3.3.1 Top View of System Main Board

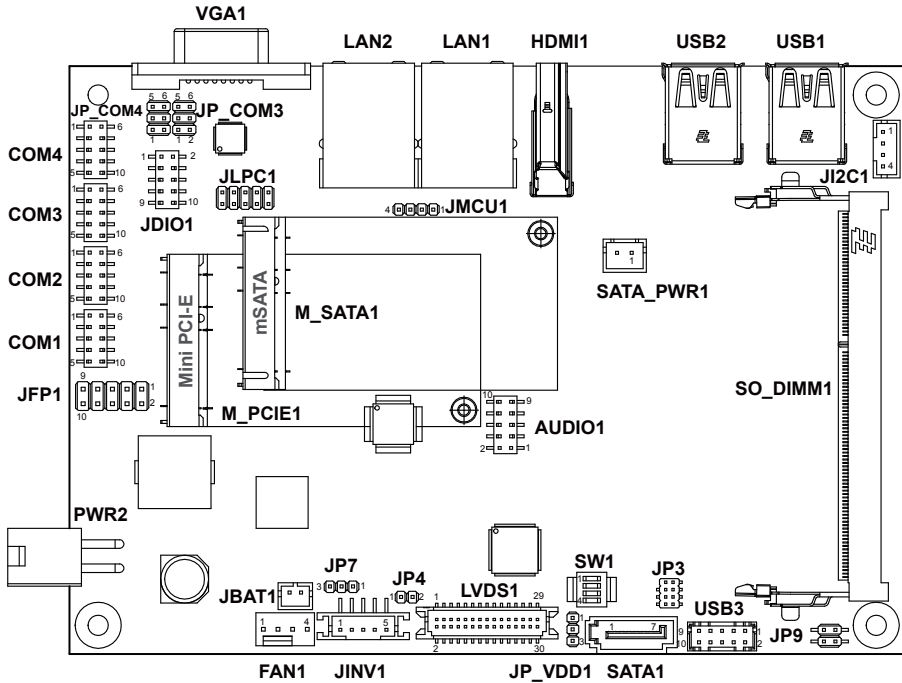





Figure 3-1. Main Board Component Location (Top View)

	<p><b>WARNING:</b> Always disconnect the power cord when you are working with connectors and jumpers on the main board. Make sure both the system and peripheral devices are turned OFF as sudden surge of power could damage sensitive components. Make sure BE-0986 is properly grounded.</p>
	<p><b>CAUTION:</b> Observe precautions while handling electrostatic sensitive components. Make sure to ground yourself to prevent static charge while you are working on the connectors and jumpers. Use a grounding wrist strap and place all electronic components in any static-shielded devices.</p>
	<p><b>CAUTION:</b> Always touch the motherboard components by the edges. Never touch components such as a processor by its pins. Take special cares while you are holding electronic circuit boards by the edges only. Do not touch the main board components.</p>
	<p><b>CAUTION:</b> As the IP66 guarantee is covered in the system warranty terms and condition, please <b>DO NOT</b> dismantle the system by yourself.</p>

3.3.2 Bottom View of System Main Board

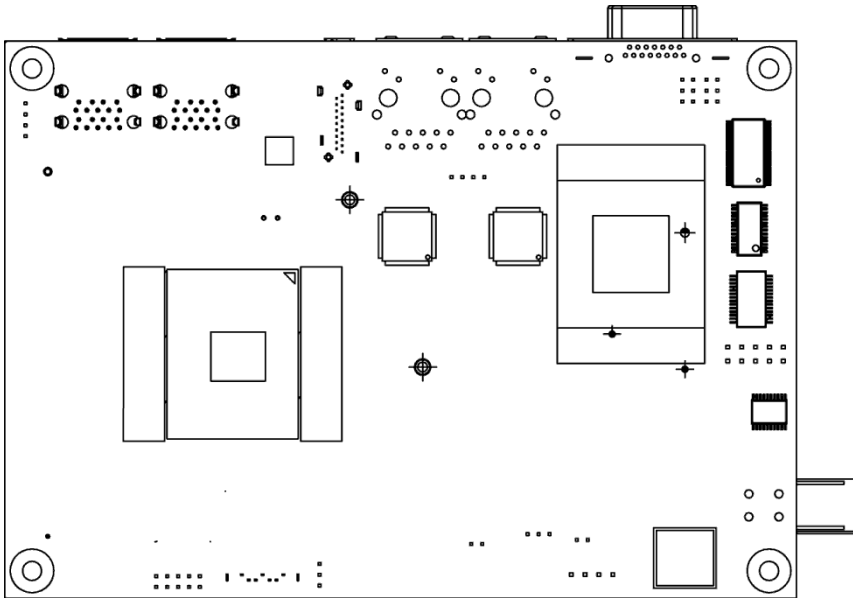

Figure 3-2. Main Board Component Location (Rear View)

### **3.4 How To Set Jumpers**

You can configure your board by setting the jumpers. A jumper consists of two or three metal pins with a plastic base mounted on the card. By using a small plastic "cap", also known as the jumper cap (with a metal contact inside), you are able to connect the pins. So you can configure your hardware settings by "opening" or "closing" jumpers.

Jumpers can be combined into sets that are called jumper blocks. When jumpers are all in the block, you have to put them together to set up the hardware configuration. The figure below shows what this looks like.

#### **Jumpers & Caps**

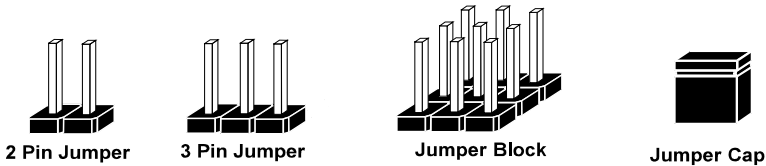

If a jumper has three pins, for example, labeled 1, 2 and 3. You can connect pins 1 and 2 to create one setting and shorting. You can also select to connect pins 2 and 3 to create another setting. The format of the jumper picture will be illustrated throughout this manual. The figure below shows different types of jumpers and jumper settings.



**Jumper diagrams**



Jumper Cap looks like this

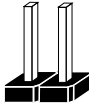

2 pin Jumper looks like this

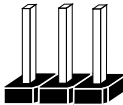

3 pin Jumper looks like this

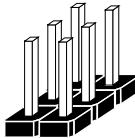

Jumper Block looks like this

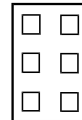

**Jumper settings**



2 pin Jumper closed(enabled)  
looks like this

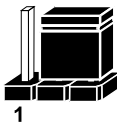

3 pin Jumper  
2-3 pin closed(enabled)  
looks like this

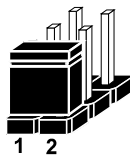
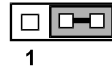

Jumper Block  
1-2 pin closed(enabled)  
looks like this

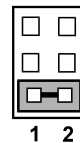

### 3.5 Setting Main Board Connectors and Jumpers

#### 3.5.1 COM3 and COM4 PIN9 Definition Selection Guide

JP\_COM3, JP\_COM4: COM3 and COM4 Port pin9 RI/5V/12V Selection

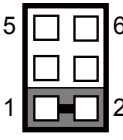
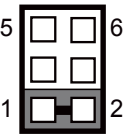
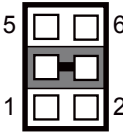
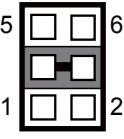
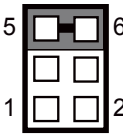
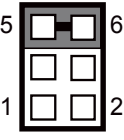
SELECTION	JUMPER SETTING	JUMPER ILLUSTRATION	
RI	1-2 <i>(Default Setting)</i>	 <p><b>JP_COM3</b></p>	 <p><b>JP_COM4</b></p>
+12V	3-4	 <p><b>JP_COM3</b></p>	 <p><b>JP_COM4</b></p>
+5V	5-6	 <p><b>JP_COM3</b></p>	 <p><b>JP_COM4</b></p>

### 3.5.2 COM Connectors (COM1, COM2)

Connector Location: COM1, COM2

Description: COM Connector

#### COM1(RS-232) Connector Pin Assignment:

PIN	ASSIGNMENT	PIN	ASSIGNMENT
1	COM1_DCD	6	COM1_DSR
2	COM1_RX	7	COM1_RTS
3	COM1_TX	8	COM1_CTS
4	COM1_DTR	9	COM1_RI
5	GND	10	NC

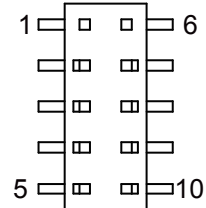

**COM1/  
COM2**

#### COM2(RS-232/RS422/RS485) Connector Pin Assignment:

PIN	ASSIGNMENT		
	RS232 <i>(Default Setting)</i>	RS422	RS485
1	COM2_DCD	TX-	D-
2	COM2_RX	TX+	D+
3	COM2_TX	RX-	NC
4	COM2_DTR	RX+	NC
5	GND	GND	GND
6	COM2_DSR	NC	NC
7	COM2_RTS	NC	NC
8	COM2_CTS	NC	NC
9	COM2_RI	NC	NC
10	NC	NC	NC

#### Notes:

1. COM2 is selectable as RS232, RS422, RS485 by BIOS setting.
2. Default setting is RS232. Please see **Chapter 5 “Advanced – Onboard Device Configuration”** for selection details.

### 3.5.3 LAN1, LAN2 Ports (LAN1, LAN2)

Port Location: LAN1, LAN2

Description: LAN1, LAN2 Port, LAN RJ-45 Port (Rear I/O)

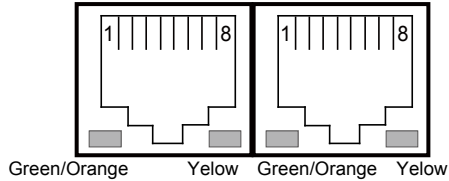

### LAN1 / LAN2

#### LAN1 Pin Assignment:

PIN	ASSIGNMENT
1	LAN1 MDIP0
2	LAN1 MDIN0
3	LAN1 MDIP1
4	LAN1 MDIP2
5	LAN1 MDIN2
6	LAN1 MDIN1
7	LAN1 MDIP3
8	LAN1 MDIN3

#### LAN2 Pin Assignment:

PIN	ASSIGNMENT
1	LAN2 MDIP0
2	LAN2 MDIN0
3	LAN2 MDIP1
4	LAN2 MDIP2
5	LAN2 MDIN2
6	LAN2 MDIN1
7	LAN2 MDIP3
8	LAN2 MDIN3

**LAN1 / LAN2 Status**

There are LAN LED indicators on the rear side of the main board. By observing their status, you can know the status of the Ethernet connection.

**LAN LED Indicator****Left Side LED**

Green Color	10/100Mbps LAN Speed Indicator
Orange Color	Giga LAN Speed Indicator
Off	No LAN Switch/HUB connect

**Right Side LED**

Yellow Color Blinking	LAN Message Active
Off	No LAN Message Active

### 3.5.4 Dual USB 3.0 Connectors (USB1)

Connector Location: **USB1**

Description: Dual USB 3.0 Connectors

USB 3.0 signals:

PIN	ASSIGNMENT	PIN	ASSIGNMENT
B5	USB3_RXN2	-	-
B6	USB3_RXP2	B4	GND
B7	GND	B3	USB2_P2_DP
B8	USB3_TXN2	B2	USB2_P2_DN
B9	USB3_TXP2	B1	VCC5_USB1
A5	USB3_RXN1	-	-
A6	USB3_RXP1	A4	GND
A7	GND	A3	USB2_P1_DP
A8	USB3_TXN1	A2	USB2_P1_DN
A9	USB3_TXP1	A1	VCC5_USB1

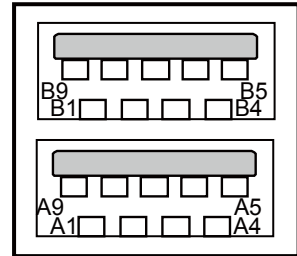

**USB1**

### 3.5.5 USB 3.0 Connectors (USB2)

Connector Location: **USB2**

Description: USB 3.0 Connectors

USB 3.0 (USB2) signals:

PIN	ASSIGNMENT	PIN	ASSIGNMENT
B5	USB3_RXN4	-	-
B6	USB3_RXP4	B4	GND
B7	GND	B3	USB2_P4_DP
B8	USB3_TXN4	B2	USB2_P4_DN
B9	USB3_TXP4	B1	VCC5_USB2
A5	USB3_RXN3	-	-
A6	USB3_RXP3	A4	GND
A7	GND	A3	USB2_P3_DP
A8	USB3_TXN3	A2	USB2_P3_DN
A9	USB3_TXP3	A1	VCC5_USB2

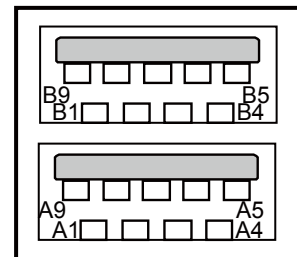

**USB2**

### 3.5.6 USB 2.0 Connector (USB3)

Connector Location: USB3

Description: USB 2.0 Connector

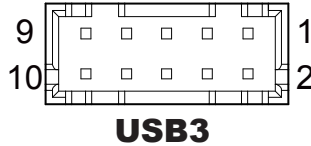

USB 2.0 (USB3) signals:

PIN	ASSIGNMENT	PIN	ASSIGNMENT
1	VCC5_USB3	2	VCC5_USB3
3	USB2_P5_DN	4	USB2_P6_DN
5	USB2_P5_DP	6	USB2_P6_DP
7	GND	8	GND
9	GND	10	GND

### 3.5.7 Programmable GPIO Pin Header (JDIO1)

Connector Location: JDIO1

Description: GPIO pin header and 5V power

PIN	ASSIGNMENT	PIN	ASSIGNMENT
1	VCC5	2	GND
3	GPI/GPO 0	4	GPI/GPO 4
5	GPI/GPO 1	6	GPI/GPO 5
7	GPI/GPO 2	8	GPI/GPO 6
9	GPI/GPO 3	10	GPI/GPO 7

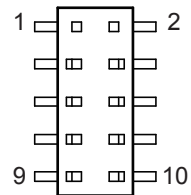

**JDIO1**

Notes:

1. Users can set the GPI/GPO configuration via Protech's API/Utility.
2. Default setting is GPI every time when system AC power is re-applied from power failure state.
3. Configuration can be still kept even in S5 state unless system AC power is lost.

### 3.5.8 I2C Wafer (JI2C1)

Wafer Location: JI2C1

Description: I2C Wafer

JI2C1 Pin Assignment:

PIN	ASSIGNMENT
1	GND
2	VCC5
3	I2C0_SCL_33
4	I2C0_SDA_33

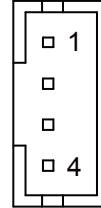

**JI2C1**

### 3.5.9 MCU FW Rewrite Connector (JMCU1)

Connector Location: JMCU1

Description: MCU FW Rewrite Connector

PIN	ASSIGNMENT
1	MCU_5VSB
2	GND
3	MCU_SPD
4	MCU_SPC



**JMCU1**

### 3.5.10 DC Power Input Connector (PWR2)

Connector Location: PWR2

Description: DC Power Input Connector

PIN	ASSIGNMENT	PIN	ASSIGNMENT
3	VCC12	4	VCC12
2	GND	1	GND

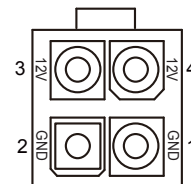

**PWR2**



### 3.5.11 System Fan Connector (FAN1)

Connector Location: FAN1

Description: System Fan Connector

PIN	ASSIGNMENT
1	GND
2	VCC12
3	SYSFANIN
4	SYSFANOUT

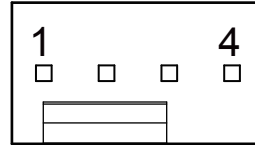

**FAN1**

**Notes:**

1. Fan speed mode can be set by BIOS or API.
2. Default BIOS setting is “Auto Duty-Cycle Mode”. Please see Chapter 5 or check API document for more details.

### 3.5.12 MINI PCI Express Slot (M\_PCIE1)

Connector Location: M\_PCIE1

Description: Mini-PCI Express Slot

PIN	ASSIGNMENT	PIN	ASSIGNMENT
1	PCIE_WAKEJ	2	V3P3S
3	Reserved	4	GND
5	Reserved	6	VCC1_5
7	M_CLKREQJ	8	Reserved
9	GND	10	Reserved
11	M_PCIE_CLKN	12	Reserved
13	M_PCIE_CLKP	14	Reserved
15	GND	16	Reserved
17	Reserved	18	GND
19	Reserved	20	Reserved
21	GND	22	PMU_PLTRST_N
23	PCIE_P2_RXN	24	V3_3SB
25	PCIE_P2_RXP	26	GND
27	GND	28	VCC1_5
29	GND	30	SMB_3P3_SCL
31	PCIE_P2_TXN	32	SMB_3P3_SDA
33	PCIE_P2_TXP	34	GND
35	GND	36	USB2_P7_DN
37	GND	38	USB2_P7_DP
39	V3P3S	40	GND
41	V3P3S	42	NC
43	GND	44	NC
45	NC	46	NC
47	NC	48	VCC1_5
49	NC	50	GND
51	NC	52	V3P3S

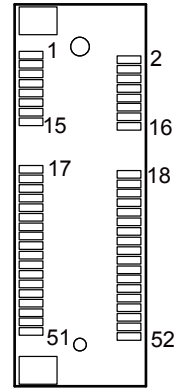

**M\_PCIE1**

**Mini PCI Express** is the successor of the Mini PCI card and provides an increased data throughput. The cards have a detached network interface and are equipped with one lane. They are used in particular in embedded designs or compact box PCs.

**3.5.13 LVDS Connector (LVDS1)**

**Connector Location: LVDS1**

**Description: LVDS Connector**

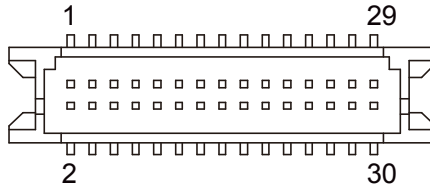

**LVDS1**







PIN	ASSIGNMENT	PIN	ASSIGNMENT
1	LVDS_VCC	2	GND
3	LVDS_CLKB_DN	4	LVDS_CLKB_DP
5	GND	6	LVDS_B2_DN
7	LVDS_B2_DP	8	GND
9	LVDS_B1_DN	10	LVDS_B1_DP
11	LVDS_B3_DP	12	LVDS_B3_DN
13	LVDS_B0_DP	14	LVDS_B0_DN
15	GND	16	LVDS_CLKA_DP
17	LVDS_CLKA_DN	18	GND
19	LVDS_A2_DP	20	LVDS_A2_DN
21	GND	22	LVDS_A1_DP
23	LVDS_A1_DN	24	GND
25	LVDS_A0_DP	26	LVDS_A0_DN
27	LVDS_A3_DP	28	LVDS_A3_DN
29	LVDS_VCC	30	LVDS_VCC





**3.5.14 Slide Switch For LVDS Resolution Selection (SW1)**

**Slide Switch Location: SW1**

**Description:** Slide Switch for LVDS Resolution/Channel/Color Bit Selection

SELECTION	SW1	PIN	SETTING
800 x 600 1CH/18bit		1	ON
		2	ON
		3	ON
		4	ON
1024 x 768 1CH/18bit <i>(Default Setting for SG-S151)</i>		1	OFF
		2	ON
		3	ON
		4	ON
1024 x 768 1CH/24bit		1	ON
		2	OFF
		3	ON
		4	ON
1280 x 768 1CH/18bit		1	OFF
		2	OFF
		3	ON
		4	ON
1200 x 800 1CH/18bit		1	ON
		2	ON
		3	OFF
		4	ON

<b>1280 x 960</b> <b>1CH/24bit</b>	OFF    ON 	1	OFF
		2	ON
		3	OFF
		4	ON
<b>1280 x 1024</b> <b>2CH/24bit</b> <i>(Default Setting for SG-S171)</i>	OFF    ON 	1	ON
		2	OFF
		3	OFF
		4	ON
<b>1366 x 768</b> <b>1CH/18bit</b>	OFF    ON 	1	OFF
		2	OFF
		3	OFF
		4	ON
<b>1366 x 768</b> <b>1CH/24bit</b>	OFF    ON 	1	ON
		2	ON
		3	ON
		4	OFF
<b>1440 x 900</b> <b>2CH/24bit</b>	OFF    ON 	1	OFF
		2	ON
		3	ON
		4	OFF
<b>1400 x 1050</b> <b>2CH/24bit</b>	OFF    ON 	1	ON
		2	OFF
		3	ON
		4	OFF

<b>1600 x 900</b> <b>2CH/24bit</b>	OFF    ON 	1	OFF
		2	OFF
		3	ON
		4	OFF
<b>1680 x 1050</b> <b>2CH/24bit</b>	OFF    ON 	1	ON
		2	ON
		3	OFF
		4	OFF
<b>1600 x 1200</b> <b>2CH/24bit</b>	OFF    ON 	1	OFF
		2	ON
		3	OFF
		4	OFF
<b>1920 x 1080</b> <b>2CH/24bit</b> <i>(Default Setting for SG-S211)</i>	OFF    ON 	1	ON
		2	OFF
		3	OFF
		4	OFF
<b>1920 x 1200</b> <b>2CH/24bit</b>	OFF    ON 	1	OFF
		2	OFF
		3	OFF
		4	OFF

### 3.5.15 Front Panel Connector (JFP1)

Connector Location: JFP1

Description: Front Panel Connector

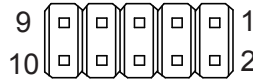

**JFP1**

PIN	ASSIGNMENT	PIN	ASSIGNMENT
1	HDD LED+	2	POWER LED+
3	HDD LED-	4	GND
5	GND	6	GND
7	RESET BTN	8	GND
9	NC	10	POWER BTN

### 3.5.16 HD Audio Connector (AUDIO1)

Connector Location: AUDIO1

Description: HD Audio Connector for Line In / Line Out / Mic In

PIN	ASSIGNMENT	PIN	ASSIGNMENT
10	LINE-OUT-R	9	LINE-OUT-L
8	HD_GND	7	HD_GND
6	HD_LINE-IN-R	5	HD_LINE-IN-L
4	HD_GND	3	HD_GND
2	HD_MIC1-R	1	HD_MIC1-L

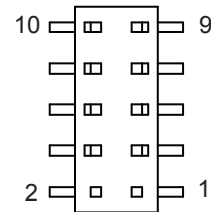

**AUDIO1**

### 3.5.17 Panel Inverter Connector (JINV1)

**Connector Location:** JINV1

**Description:** Panel Inverter Connector

PIN	ASSIGNMENT
1	VCC12
2	VCC12
3	GND
4	LVDS_BKLCTL
5	LVDS_BKLTEN

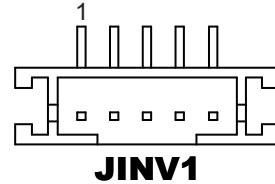

### 3.5.18 Serial ATA (SATA) 3.0 Connector (SATA1)

**Connector Location:** SATA1

**Description:** Serial ATA (SATA) 3.0 Connector

PIN	ASSIGNMENT
1	GND
2	SATA_TXP0
3	SATA_TXN0
4	GND
5	SATA_RXN0
6	SATA_RXP0
7	GND

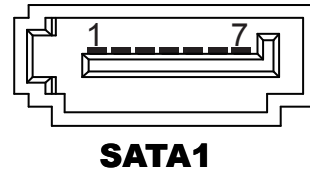

### 3.5.19 SATA Power Connector (SATA\_PWR1)

**Connector Location:** SATA\_PWR1

**Description:** Serial ATA Power Connector

PIN	ASSIGNMENT
1	VCC5
2	GND

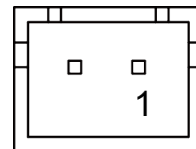



### 3.5.20 BIOS Reset Connector (JP9)



**Connector Location:** JP9

**Description:** This connector is only for Protech's engineers. (Purpose: BIOS reset). Please do not use this connector; otherwise, the system might be crashed.

### 3.5.21 LVDS Backlight Control Selection (JP7)

**Jumper Location:** JP7

**Description:** Jumper for selecting PIN5 (LVDS\_BKLTEN) voltage of JINV1.

SELECTION	JUMPER SETTING	JUMPER ILLUSTRATION
3.3V	<i>1-2 (Default Setting)</i>	 <b>JP7</b>
5V	2-3	 <b>JP7</b>

**Note 1:** Users can change the setting according to panel specification

**Note 2:** Please refer to **PANEL INVERTER CONNECTOR** for more details about pin definition of JINV1.

**3.5.22 LVDS VCC Voltage Selection (JP\_VDD1)**

**Jumper Location:** JP\_VDD1

**Description:** Voltage selection jumper for selecting PIN1, PIN29, PIN30 (LVDS\_VCC) voltage of LVDS1.

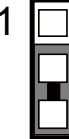
SELECTION	JUMPER SETTING	JUMPER ILLUSTRATION
3.3V	1-2 <i>(Default Setting for SG-S151)</i>	 <p><b>JP_VDD1</b></p>
5V	2-3 <i>(Default Setting for SG-S171 and SG-S211)</i>	 <p><b>JP_VDD1</b></p>

**Note:** Please refer to **PANEL INVERTER CONNECTOR** for more information about pin definition of JINV1.

**3.5.23 Clear CMOS Data Selection (JP4)**

**Jumper Location: JP4**

**Description:** Clear CMOS Data Selection

- Step 1.** Remove the main power of the PC.
- Step 2.** Close JP4 (pins 1-2) for 6 seconds by a cap.
- Step 3.** Remove the cap which is just used on JP4 (1-2), so that JP4 returns to “OPEN”.
- Step 4.** Power on the PC and the PC will then auto-reboot for once in order to set SoC’s register.
- Step 5.** Done!

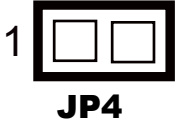
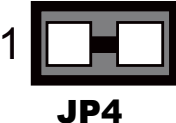
SELECTION	JUMPER SETTING	JUMPER ILLUSTRATION
Normal	Open <i>(Default Setting)</i>	
Clear CMOS*	1-2	

**Note:** Please make sure the main power is off before clearing CMOS.

### 3.6 External M12 Waterproof Connectors

#### 3.6.1 USB 2.0 Connectors

Connector Location: **USB 2.0**

Description: External USB 2.0 connectors

Pin Assignment:

PIN	ASSIGNMENT
1	USB0_VCC5
2	USB0_P1_DN
3	USB0_P2_DP
4	USB0_GND
5	USB1_VCC5
6	USB1_P1_DN
7	USB1_P2_DP
8	USB1_GND

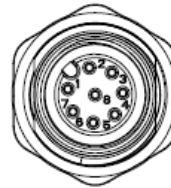

**USB 2.0**

#### 3.6.2 Power Button

Location: **Power Button**

Description: Power Button

PIN	ASSIGNMENT
1	Power BTN
2	Power LED +
3	GND
4	GND



**Power Button**

### 3.6.3 LAN1, LAN2 Ports

Port Location: LAN1, LAN2

Description: LAN1, LAN2 Port

#### LAN1 Pin Assignment:

PIN	ASSIGNMENT
1	LAN1_MDIP0
2	LAN1_MDIN0
3	LAN1_MDIP1
4	LAN1_MDIP2
5	LAN1_MDIN2
6	LAN1_MDIN1
7	LAN1_MDIP3
8	LAN1_MDIN3

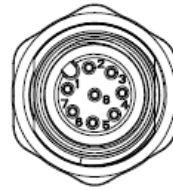

**LAN1 / LAN2**

#### LAN2 Pin Assignment:

PIN	ASSIGNMENT
1	LAN2_MDIP0
2	LAN2_MDIN0
3	LAN2_MDIP1
4	LAN2_MDIP2
5	LAN2_MDIN2
6	LAN2_MDIN1
7	LAN2_MDIP3
8	LAN2_MDIN3

### 3.6.4 COM Connector

Connector Location: COM2

Description: COM2 Connector

Pin Assignment:

PIN	ASSIGNMENT		
	RS-232 <i>(Default Setting)</i>	RS-422	RS-485
1	COM2 DCD#	TX-	D-
2	COM2 RX	TX+	D+
3	COM2 TX	RX-	NC
4	COM2 DTR	RX+	NC
5	COM2 DSR	NC	NC
6	COM2 RTS	NC	NC
7	COM2 CTS	NC	NC
8	COM2 RI	NC	NC

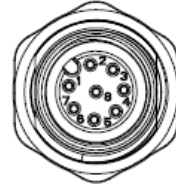

**COM2**

### 3.6.5 DC Power Input Connector

Connector Location: DC In

Description: DC Power Input Connector

PIN	ASSIGNMENT
1	PWR_VCC12
2	PWR_GND
3	GND
4	Power BTN

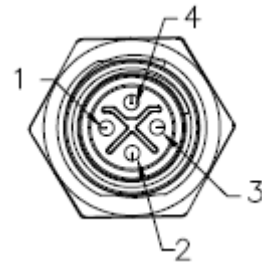

**DC In**

# 4 Software Utilities

---

This chapter provides the detailed information that guides users to install driver utilities for the system. The following topics are included:

- Installing Intel<sup>®</sup> Chipset Software Installation Utility
- Installing Intel<sup>®</sup> Trusted Execution Engine Driver Utility
- Installing Microsoft Hotfix kb3211320 and kb3213986 Driver Utility
- Installing Graphics Driver Utility
- Installing LAN Driver Utility
- Installing Sound Driver Utility
- Installing Intel<sup>®</sup> Serial I/O Driver Utility

### 4.1 Introduction

Enclosed with SG-S151 / SG-S171 / SG-S211 Series package is our driver utilities contained in a DVD-ROM disk. Refer to the following table for driver locations:

Filename (Assume that DVD-ROM drive is D :)	Purpose
D:\Driver\Platform\1_Main Chip\Win10 2016(64Bit)	Intel(R) Chipset Device Software Installation Utility
D:\Driver\Platform\2_Hotfix\Win10 2016(64Bit)	Microsoft Hotfix kb3211320 and kb3213986
D:\Driver\Platform\3_Graphics\Win10 2016(64Bit)	Intel Graphics Driver installation
D:\Driver\Platform\4_TXE\Win10 2016(64Bit)	Intel(R) Trusted Execution Engine
D:\Driver\Platform\5_LAN Chip\Win10 2016(64Bit)	Intel(R) Network Connections Software
D:\Driver\Platform\6_Sound Codec\Win10 2016(64Bit)	Realtek High Definition Audio driver installation
D:\Driver\Platform\7_Serial IO\Win10 2016(64Bit)	Intel(R) Serial IO Driver

**Note:** Install the driver utilities immediately after the OS installation is completed.

	<p><b>WARNING:</b> It is <b><u>strongly recommended</u></b> that you follow the installation sequence below:</p> <ol style="list-style-type: none"> <li>(1) Chipset Driver</li> <li>(2) Graphics Driver</li> <li>(3) TXE Driver</li> <li>(4) Other Drivers</li> </ol>
---	---



## **4.2 Installing Intel® Chipset Software Installation Utility**

The Intel® Chipset Software Installation Utility installs the Windows \*.INF files to the target system. These files outline to the operating system how to configure the Intel chipset components in order to ensure that the following functions work properly:

- Core PCI and ISAPNP Services
- PCIe Support
- SATA Storage Support
- USB Support
- Identification of Intel® Chipset Components in the Device Manager

The utility pack is to be installed only for Windows® 10 series, and it should be installed immediately after the OS installation is finished.

Please follow the steps below:

- 1** Connect the USB DVD-ROM device to SG-S151 / SG-S171 / SG-S211 and insert the driver disk.
- 2** Enter the **Main Chip** folder where the Chipset driver is located
- 3** Click **SetupChipset.exe** file for driver installation.
- 4** Follow the on-screen instructions to install the driver.
- 5** Once the installation is completed, shut down the system and restart SG-S151 / SG-S171 / SG-S211 for the changes to take effect.

### 4.3 Installing Intel® Trusted Execution Engine Installation Utility

To install the utility, simply follow the steps below:

- 1** Connect the USB DVD-ROM device to SG-S151 / SG-S171 / SG-S211 and insert the driver disk.
- 2** Enter the **TXE** folder where the driver is located.
- 3** Click the **SetupTXE.exe** file for driver installation.
- 4** Follow the on-screen instructions to complete the installation.
- 5** Once the installation is completed, shut down the system and restart SG-S151 / SG-S171 / SG-S211 for the changes to take effect.

#### 4.4 Installing Microsoft Hotfix kb3211320 and kb3213986 Driver

The Microsoft Hotfix kb3211320 and kb3213986 Driver that needs to be installed depends on the system's specific hardware and firmware features. The installer, compatible with Windows 10, detects the system's capabilities and installs the relevant drivers and applications.

To install the utility, simply follow the steps below:

- 1 Connect the USB DVD-ROM device to SG-S151 / SG-S171 / SG-S211 and insert the driver disk.
- 2 Enter the **Hotfix** folder where the driver is located.
- 3 Click the **windows10.0-kb3211320-x64\_2abc94fceb4d1cdd908b3bdba473e28e0c061a3d** and **windows10.0-kb3213986-x64\_a1f5adacc28b56d7728c92e318d6596d9072aec4** files for critical security update.
- 4 Follow the on-screen instructions to complete the installation.
- 5 Once the installation is completed, shut down the system and restart SG-S151/SG-S171/SG-S211 for the changes to take effect.

## **4.5 Installing Graphics Driver Utility**

The GRAPHICS interface embedded in SG-S151/SG-S171/SG-S211 can support a wide range of display types. You can have dual displays via LVDS interfaces and make the system work simultaneously.

To install the Graphics driver utility, follow the steps below:

- 1** Connect the USB DVD-ROM device to SG-S151 / SG-S171 / SG-S211 and insert the driver disk.
- 2** Enter the **Graphics** folder where the driver is located
- 3** Click the **Setup.exe** file for driver installation.
- 4** Follow the on-screen instructions to complete the installation.
- 5** Once the installation is completed, shut down the system and restart SG-S151 / SG-S171 / SG-S211 for the changes to take effect.

## **4.6 Installing LAN Driver Utility**

Enhanced with LAN function, SG-S151/SG-S171/SG-S211 supports various network adapters. To install the LAN Driver, follow the steps below:

- 1** Connect the USB DVD-ROM device to SG-S151 / SG-S171 / SG-S211 and insert the driver disk.
- 2** Enter the **LAN Chip** folder where the driver is located
- 3** Click **Autorun.exe** file for driver installation.
- 4** Follow the on-screen instructions to complete the installation.
- 5** Once the installation is completed, shut down the system and restart SG-S151 / SG-S171 / SG-S211 for the changes to take effect.

**For more details on the installation procedure, refer to the Readme.txt file that you can find on LAN Driver Utility.**

## 4.7 Installing Sound Driver Utility

The sound function enhanced in this system is fully compatible with Windows® 10 series.

To install the Sound Driver, follow the steps below:

- 1** Connect the USB DVD-ROM device to SG-S151 / SG-S171 / SG-S211 and insert the driver disk.
- 2** Open the **Sound Codec** folder where the driver is located
- 3** Click the **Setup.exe** for driver installation.
- 4** Follow the on-screen instructions to complete the installation.
- 5** Once the installation is completed, shut down the system and restart SG-S151 / SG-S171 / SG-S211 for the changes to take effect.

## 4.8 Installing Intel® Serial I/O Driver Utility

To install the Serial I/O Driver, follow the steps below:

- 1** Connect the USB DVD-ROM device to SG-S151 / SG-S171 / SG-S211 and insert the driver disk.
- 2** Open the **Serial IO** folder where the driver is located.
- 3** Select Windows 10 (64-bit) for your OS platform.
- 4** Click the **SetupSerialIO.exe** file for driver installation.
- 5** Follow the on-screen instructions to complete the installation.
- 6** Once the installation is completed, shut down the system and restart SG-S151 / SG-S171 / SG-S211 for the changes to take effect.

# 5

## BIOS SETUP

---

This chapter guides users how to configure the basic system configurations via the BIOS Setup Utilities. The information of the system configuration is saved in BIOS NVRAM so that the Setup information is retained when the system is powered off. The BIOS Setup Utilities consist of the following menu items:

- Main Menu
- Advanced Menu
- Chipset Menu
- Security Menu
- Boot Menu
- Save & Exit Menu



## 5.1 Introduction

The SG-S151 / SG-S171 / SG-S211 System uses an AMI (American Megatrends Incorporated) Aptio BIOS that is stored in the Serial Peripheral Interface Flash Memory (SPI Flash) and can be updated. The SPI Flash contains the built-in BIOS setup program, Power-On Self-Test (POST), PCI auto-configuration utility, LAN EEPROM information, and Plug and Play support.

Aptio is AMI's BIOS firmware based on the UEFI (Unified Extensible Firmware Interface) specifications and the Intel Platform Innovation Framework for EFI. The UEFI specification defines an interface between the operating system and platform firmware. The interface consists of data tables that contain platform-related information, boot service calls, and runtime service calls that are available to the operating system and its loader. These elements have combined to provide a standard environment for booting the operating system and running pre-boot applications.

The diagram below shows the Extensible Firmware Interface's location in the software stack.

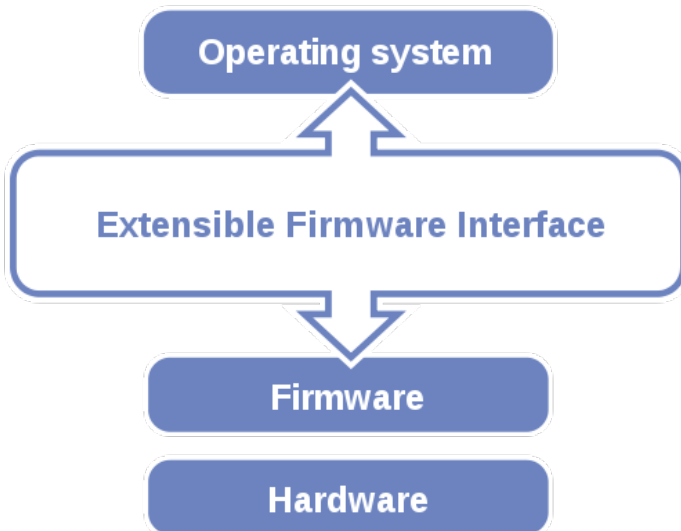

Figure 5-1. Extensible Firmware Interface Diagram

EFI BIOS provides an user interface that allows you to modify hardware configuration, e.g. change the system date and time, enable/disable a system component, determine bootable device priority, set up personal password, etc., which is convenient for engineers to perform modifications and customize the computer system and allows technicians to troubleshoot the occurred errors when the hardware is faulty.

The BIOS setup menu allows users to view and modify the BIOS settings for the computer. After the system is powered on, users can access the BIOS setup menu by pressing <Del> or <Esc> immediately while the POST message is running before the operating system is loading.

All the menu settings are described in details in this chapter.

## 5.2 Accessing Setup Utility

After the system is powered on, BIOS will enter the Power-On Self-Test (POST) routines and the POST message will be displayed:



Figure 5-2. POST Screen with AMI Logo

Press **<Del>** or **<Esc>** to access the Setup Utility program and the **Main** menu of the Aptio Setup Utility will appear on the screen as below:

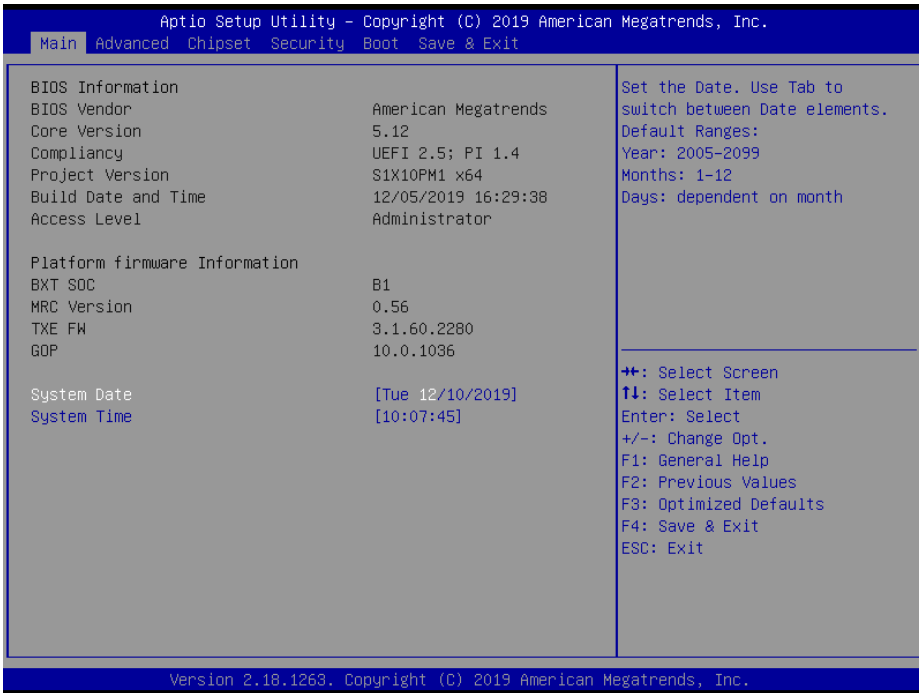

### BIOS Setup Menu Initialization Screen

You may move the cursor by <↑> and <↓> keys to highlight the individual menu items. As you highlight each item, a brief description of the highlighted selection will appear on the right side of the screen.

The language of the BIOS setup menu interface and help messages are shown in US English. You may use <↑> or <↓> key to select among the items and press <Enter> to confirm and enter the sub-menu. The following table provides the list of the navigation keys that you can use while operating the BIOS setup menu.

<b>BIOS Setup Navigation Key</b>	<b>Description</b>
<←> and <→>	Select a different menu screen (move the cursor from the selected menu to the left or right).
<↑> and <↓>	Select a different item (move the cursor from the selected item upwards or downwards)
<Enter>	Execute the command or select the sub-menu.
<F2>	Load the previous configuration values.
<F3>	Load the default configuration values.
<F4>	Save the current values and exit the BIOS setup menu.
<Esc>	Close the sub-menu. Trigger the confirmation to exit BIOS setup menu.

### 5.3 Main

Menu Path *Main*

The **Main** menu allows you to view the BIOS Information, change the system date and time, and view the user access privilege level. Use tab to switch between date elements. Use <↑> or <↓> arrow keys to highlight the item and enter the value you want in each item. This screen also displays the BIOS version (project) and BIOS Build Date and Time.

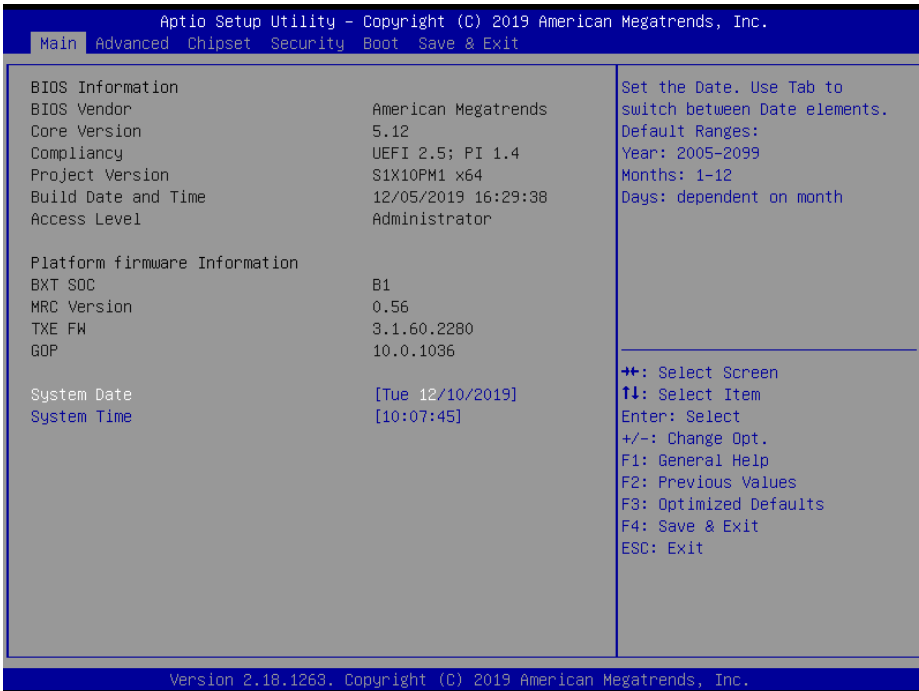

**Main Screen**

BIOS Setting	Options	Description/Purpose
BIOS Vendor	No changeable options	Displays the BIOS vendor.
Core Version	No changeable options	Displays the current BIOS core version.
Compliance	No changeable options	Displays the current UEFI version.
Project Version	No changeable options	Displays the version of the BIOS currently installed on the platform.
Build Date and Time	No changeable options	Displays the date of current BIOS version.
Access Level	No changeable options	Displays the current access level.
BXT SOC	No changeable options	Displays the SOC stepping.
MRC Version	No changeable options	Displays the MRC version.

<b>BIOS Setting</b>	<b>Options</b>	<b>Description/Purpose</b>
TXE FW	No changeable options	Displays the TXE FW version.
GOP	No changeable options	Displays the GOP version.
System Date	Month, day, year	Sets the system date. The format is [Day Month/ Date/ Year]. Users can directly enter values or use <+> or <-> arrow keys to increase/decrease it. The “Day” is automatically changed.
System Time	Hour, minute, second	Sets the system time. The format is [Hour: Minute: Second]. Users can directly enter values or use <+> or <-> arrow keys to increase/decrease it.

## 5.4 Advanced

Menu Path                      *Advanced*

This menu provides advanced configurations such as ACPI Settings, Onboard Device Configuration, Hardware Monitor, F81964 Watchdog, S5 RTC Wake Settings, CPU Configuration, F81964 Super IO Configuration and USB Configuration

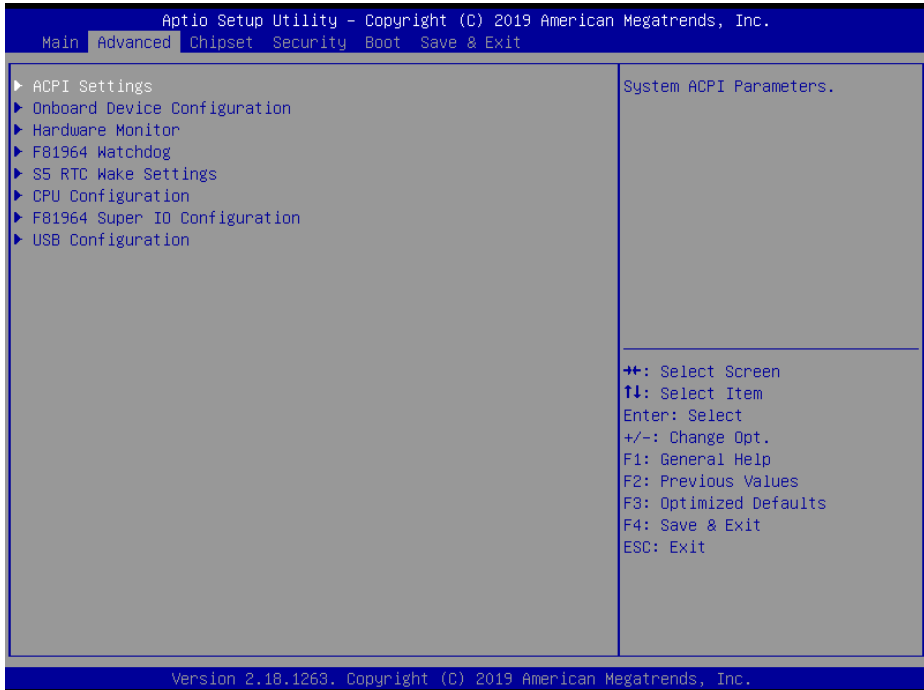

**Advanced Menu Screen**

BIOS Setting	Options	Description/Purpose
ACPI Settings	Sub-Menu	System ACPI parameters.
Onboard Device Configuration	Sub-Menu	Project-specific parameters.
Hardware Monitor	Sub-Menu	Monitor hardware status.
F81964 Watchdog	Sub-Menu	Watchdog timer parameters.
S5 RTC Wake Settings	Sub-Menu	RTC wake parameters.
CPU Configuration	Sub-Menu	CPU configuration parameters.
F81964 Super IO Configuration	Sub-Menu	System Super I/O chip parameters
USB Configuration	Sub-Menu	USB configuration parameters.



## 5.4.1 Advanced - ACPI Settings

Menu Path *Advanced > ACPI Settings*

The **ACPI Settings** allows users to configure relevant ACPI (Advanced Configuration and Power Management Interface) settings, such as Enable Hibernation (S4) and Enable Sleep (S3).

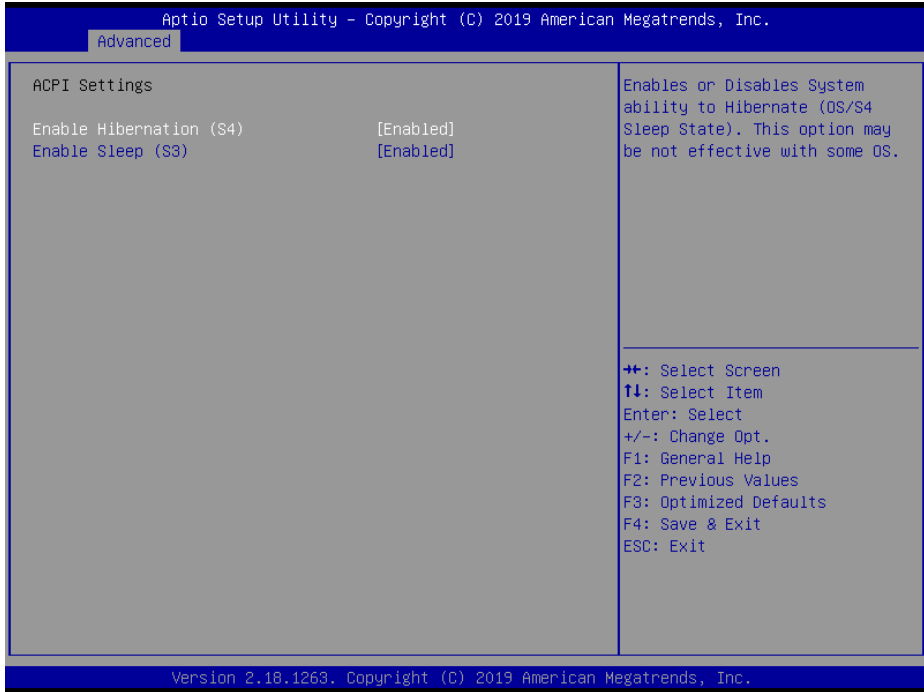

**ACPI Settings Screen**

BIOS Setting	Options	Description/Purpose
Enable Hibernation (S4)	- Disabled - <b>Enabled (default)</b>	Enables or Disables System ability to Hibernation (OS/S4 Sleep State). This option may be not effective with some OS.
Enable Sleep (S3)	- Disabled - <b>Enabled (default)</b>	Enables or Disables System ability to Sleep (OS/S3 Sleep State).

## 5.4.2 Advanced – Onboard Device Configuration

Menu Path *Advanced > Onboard Device Configuration*

The **Onboard Device Configuration** allows users to select COM2 Mode.



**Onboard Device Configuration Screen**

BIOS Setting	Options	Description/Purpose
COM2 Mode Selection	- RS-422 - <b>RS-232 (default)</b> - RS-485	Selects COM2 mode.

### 5.4.3 Advanced – Hardware Monitor

Menu Path *Advanced > Hardware Monitor*

The **Hardware Monitor** allows users to monitor the health and status of the system such as CPU temperature, system temperature, system fan speed and voltage levels in supply.

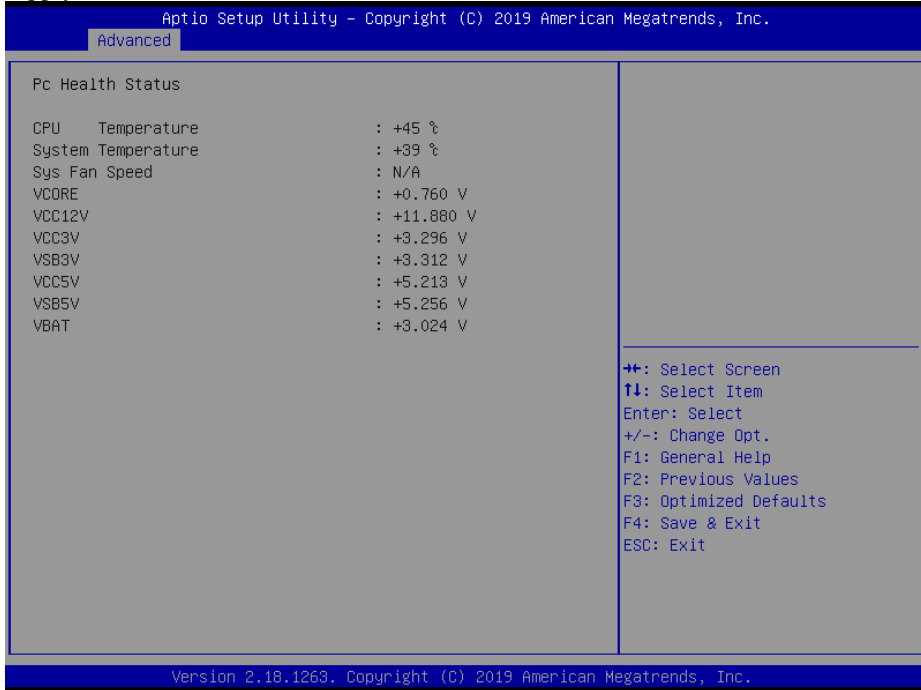

**Hardware Monitor Screen**

BIOS Setting	Options	Description/Purpose
CPU Temperature	No changeable options	Displays the processor's temperature.
System Temperature	No changeable options	Displays the system's temperature.
Sys Fan Speed	No changeable options	Displays system fan speed.
VCORE	No changeable options	Detects and displays the voltage level of VCORE in supply.
VCC12V	No changeable options	Detects and displays the voltage level of VCC12V.
VCC3V	No changeable options	Detects and displays the voltage level of VCC3V in supply.
VSB3V	No changeable options	Detects and displays the voltage level of VSB3V.

BIOS Setting	Options	Description/Purpose
VCC5V	No changeable options	Detects and displays the voltage level of VCC5V in supply.
VSB5V	No changeable options	Detects and displays the voltage level of VSB5V in supply.
VBAT	No changeable options	Detects and displays the voltage level of VBAT.

### 5.4.4 Advanced – F81964 Watchdog Configuration

Menu Path *Advanced > F81964 Watchdog*

If the system hangs or fails to respond, enable the F81964 watchdog function to trigger a system reset via the 255-level watchdog timer.

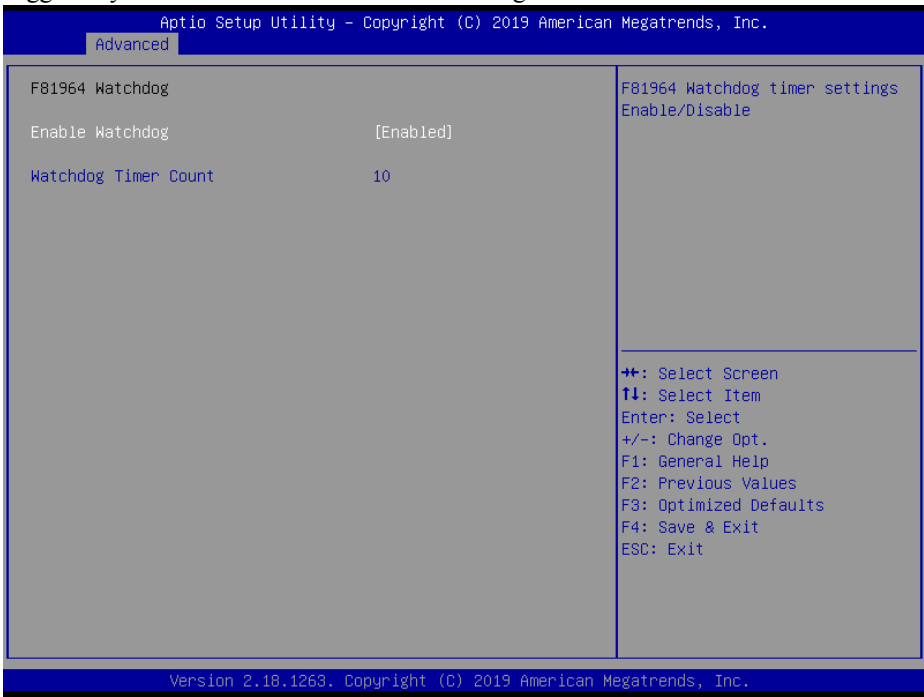

**F81964 Watchdog Configuration Screen**

BIOS Setting	Options	Description/Purpose
Enable Watchdog	- Enabled - Disabled (default)	Enables/Disables F81964 Watchdog timer settings.
Watchdog Timer Count	Numeric (from 10 to 255)	Sets the timeout for Watchdog timer. Watchdog Timer = 1sec * Count

### 5.4.5 Advanced – S5 RTC Wake Settings

Menu Path *Advanced > S5 RTC wake Settings*

The **S5 RTC Wake Settings** enables/disables the system to wake up at a preset time of a day from S5 State using RTC alarm.

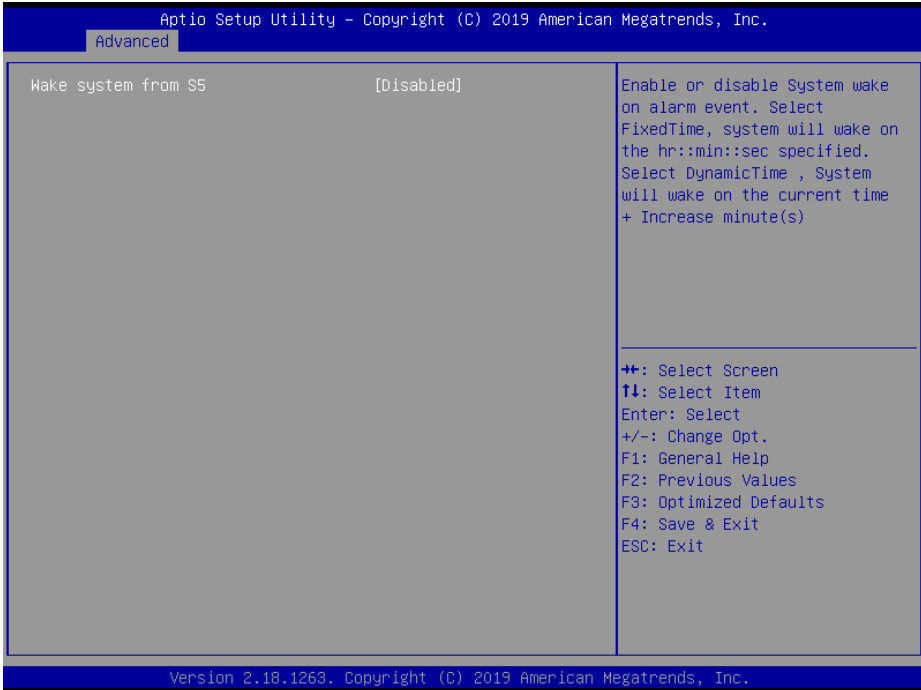

**S5 RTC Wake Settings Screen**

BIOS Setting	Options	Description/Purpose
Wake system from S5	<ul style="list-style-type: none"> <li>- Disabled (default)</li> <li>- Fixed Time</li> <li>- Dynamic Time</li> </ul>	<p>Enables or disables System wake on alarm event.</p> <ul style="list-style-type: none"> <li>• <b>Fixed Time:</b> The system will wake on the time (hr::min::sec) specified.</li> <li>• <b>Dynamic Time:</b> The system will wake on the current time + increased minute(s).</li> </ul>

5.4.5.1 S5 RTC Wake Settings [Fixed Time]

Menu Path *Advanced > S5 RTC Wake Settings [Fixed Time]*

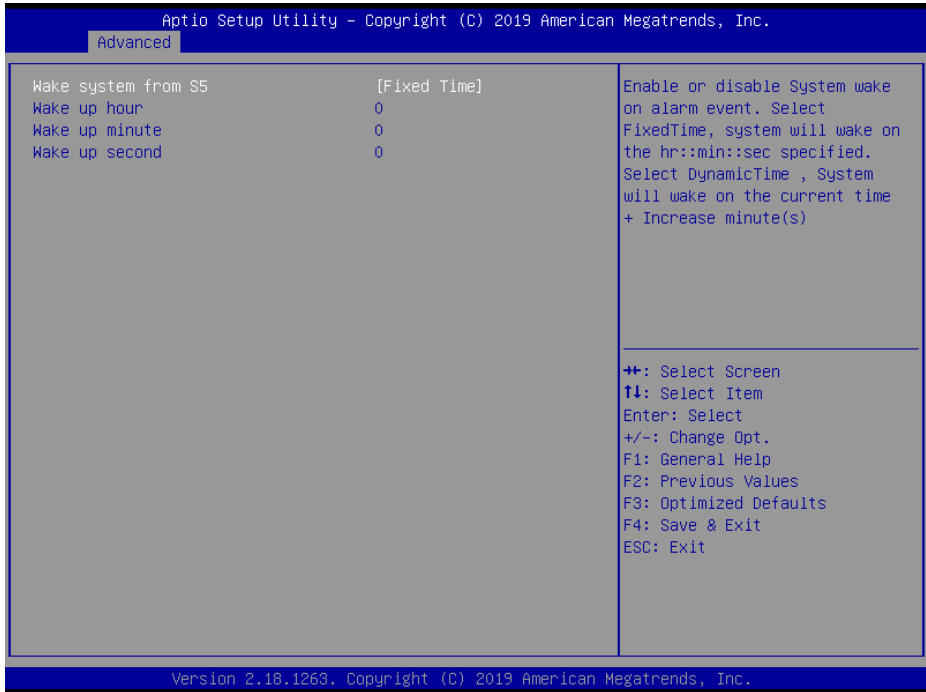

S5 RTC Wake Settings Screen (Fixed Time)

BIOS Setting	Options	Description/Purpose
Wake up hour	(Numeric) from 0 to 23	Sets an hour for a scheduled power-on event.
Wake up minute	(Numeric) from 0 to 59	Sets a minute for a scheduled power-on event.
Wake up second	(Numeric) from 0 to 59	Sets a second for a scheduled power-on event.

5.4.5.2 S5 RTC Wake Settings [Dynamic Time]

Menu Path *Advanced > S5 RTC Wake Settings [Dynamic Time]*

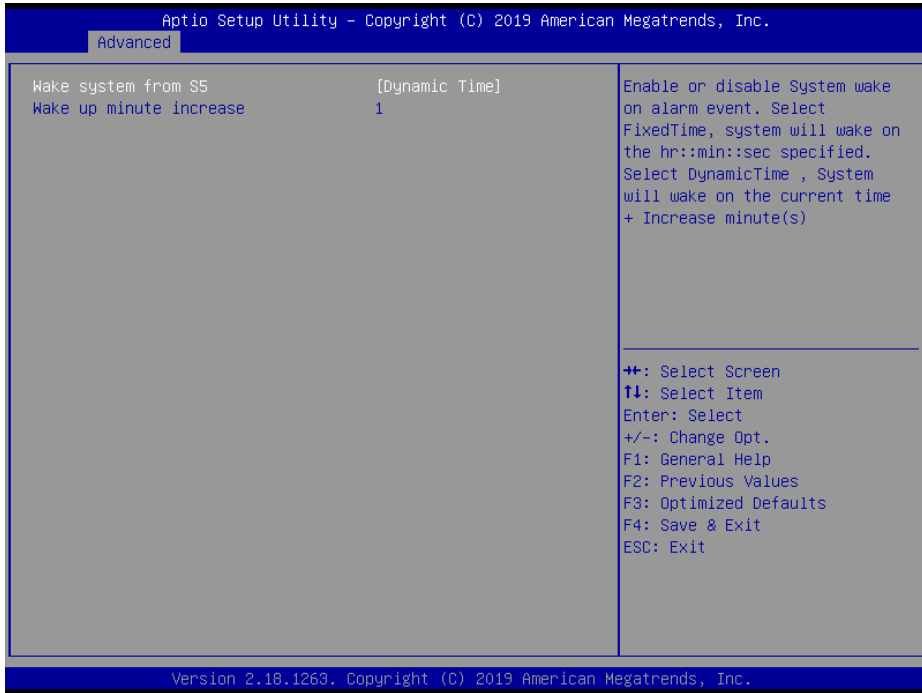

S5 RTC Wake Setting Screen (Dynamic Time)

BIOS Setting	Options	Description/Purpose
Wake up minute increase	(Numeric) from 1 to 5	Sets a period of time (in minutes) to wake up the system after it enters S5 state.

## 5.4.6 Advanced – CPU Configuration

Menu Path *Advanced > CPU Configuration*

The **CPU Configuration** provides advanced CPU settings such as configuring Socket 0 CPU information, CPU power management and some information about CPU.

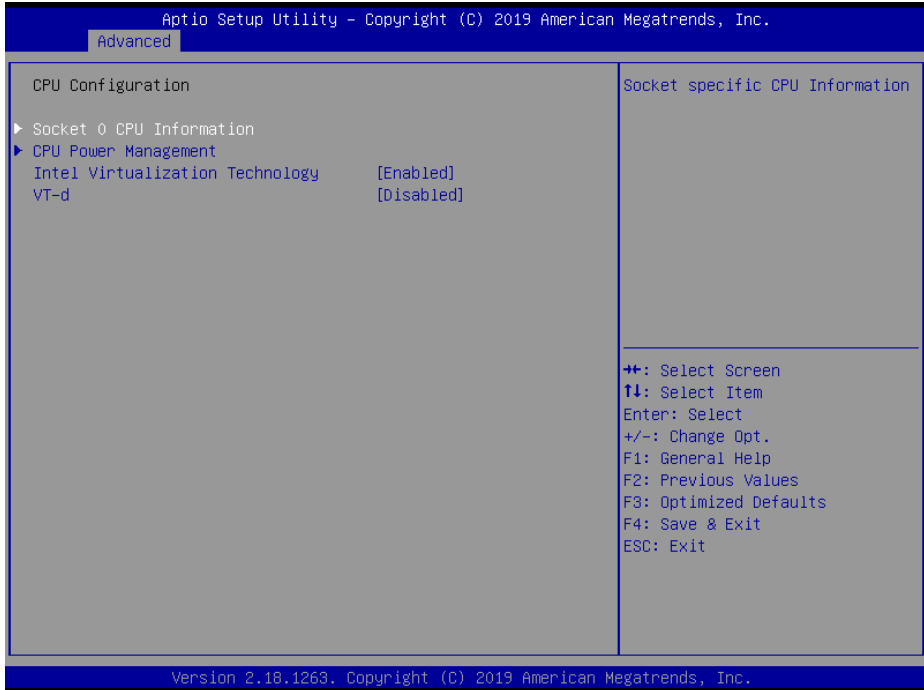

**CPU Configuration Screen**

BIOS Setting	Options	Description/Purpose
Socket 0 CPU Information	Sub-Menu	Socket specific CPU Information.
CPU Power Management	Sub-Menu	CPU power management options.
Intel Virtualization Technology	- Disabled - Enabled (default)	When enabled, a VMM can utilize the additional hardware capabilities provided by Vanderpool Technology.
VT-d	- Disabled (default) - Enabled	Enables/Disables CPU VT-d.



5.4.6.1 Socket 0 CPU Information

Menu Path *Advanced > CPU Configuration > Socket 0 CPU Information*

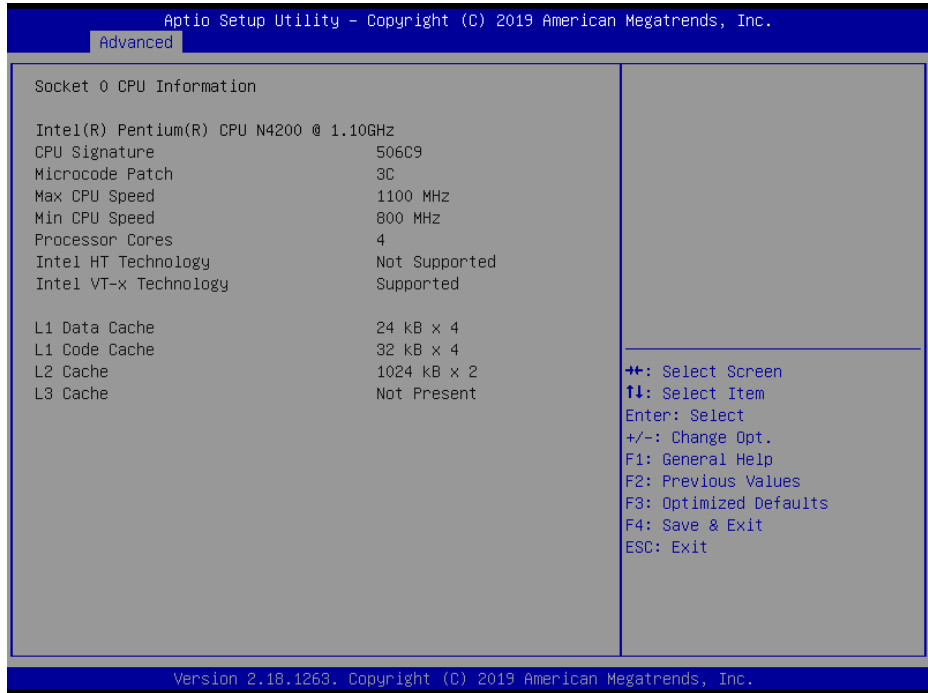

Socket 0 CPU Information Screen

BIOS Setting	Options	Description/Purpose
CPU Branding String	No changeable options	Displays CPU Branding String.
CPU Signature	No changeable options	Displays CPU Signature.
Microcode Patch	No changeable options	CPU Microcode Patch Revision.
Max CPU Speed	No changeable options	Displays the maximum CPU speed.
Min CPU Speed	No changeable options	Displays the Minimum CPU speed.
Processor Cores	No changeable options	Displays number of cores.
Intel HT Technology	No changeable options	Displays Hyper Threading support.
Intel VT-x Technology	No changeable options	Displays VT-x support.
L1 Data Cache	No changeable options	Displays L1 Data Cache Size.
L1 Code Cache	No changeable options	Displays L1 Code Cache Size.
L2 Cache	No changeable options	Displays L2 Cache Size.
L3 Cache	No changeable options	Displays L3 Cache Size.

**5.4.6.2 CPU Power Management Configuration**

Menu Path *Advanced > CPU Configuration > CPU Power Management Configuration*

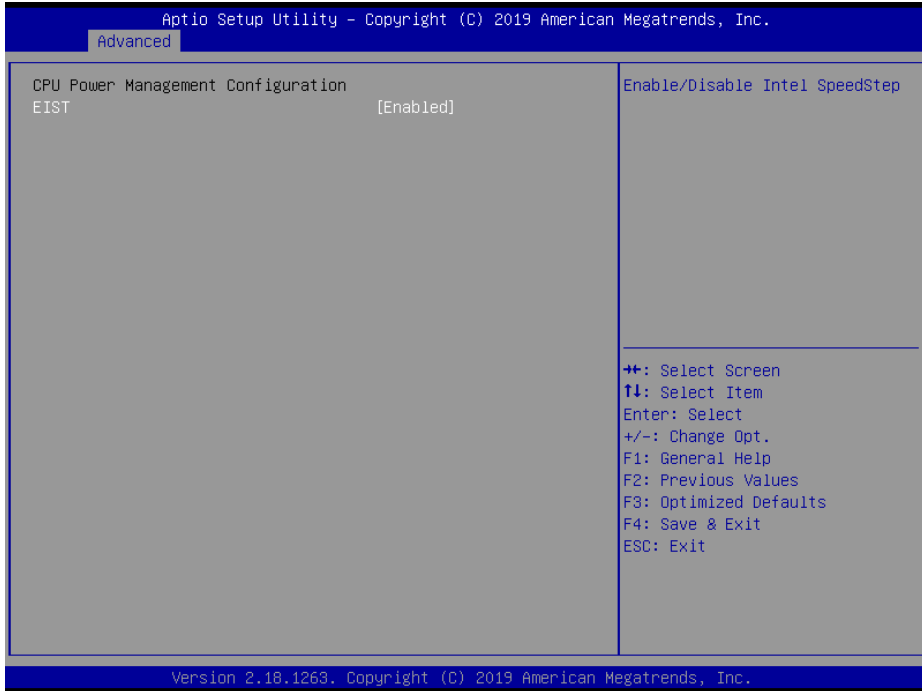

**CPU Power Management Configuration Screen**

BIOS Setting	Options	Description/Purpose
EIST	- Disabled - Enabled (default)	Enables/Disables Intel Speed Step feature for dynamic scaling processor frequency.

## 5.4.7 Advanced – F81964 Super IO Configuration

Menu Path *Advanced > F81964 Super IO Configuration*



**F81964 Super IO Configuration Screen**

BIOS Setting	Options	Description/Purpose
Super IO Chip (F81964)	No changeable options	Displays the super I/O chip model.
Serial Port	Sub-Menu	COM2 parameters.

Menu Path *Advanced > F81964 Super IO Configuration > Serial Port Configuration*

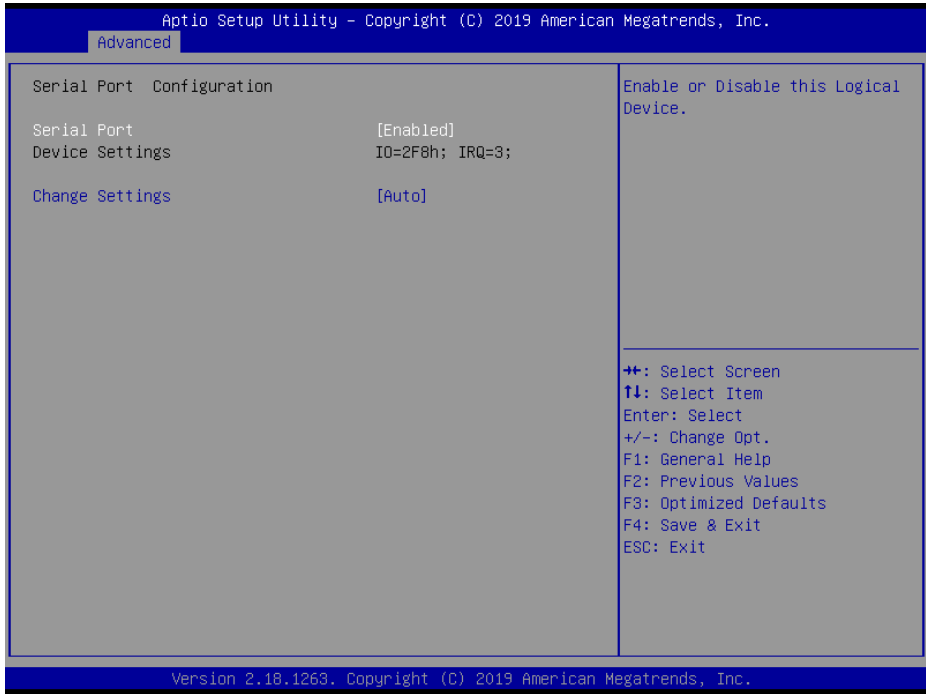

**Serial Port Configuration Screen**

BIOS Setting	Options	Description/Purpose
Serial Port	-Disabled -Enabled (default)	Enables/Disables COM2.
Device Settings	No changeable options	Reports the current COM setting.
Change Settings	-Auto (default) -IO=2F8h; IRQ=3 -IO=3F8h; IRQ=3,4,5,7,9,10,11,12; -IO=2F8h; IRQ=3,4,5,7,9,10,11,12; -IO=3E8h; IRQ=3,4,5,7,9,10,11,12; -IO=2E8h; IRQ=3,4,5,7,9,10,11,12;	Allows users to change Device's Resource settings. New settings will be reflected on this Setup Page after System restarts.

## 5.4.8 Advanced – USB Configuration

Menu Path *Advanced > USB Configuration*

The **USB Configuration** allows users to configure advanced USB settings such as USB mass storage driver support and Mass Storage Devices.

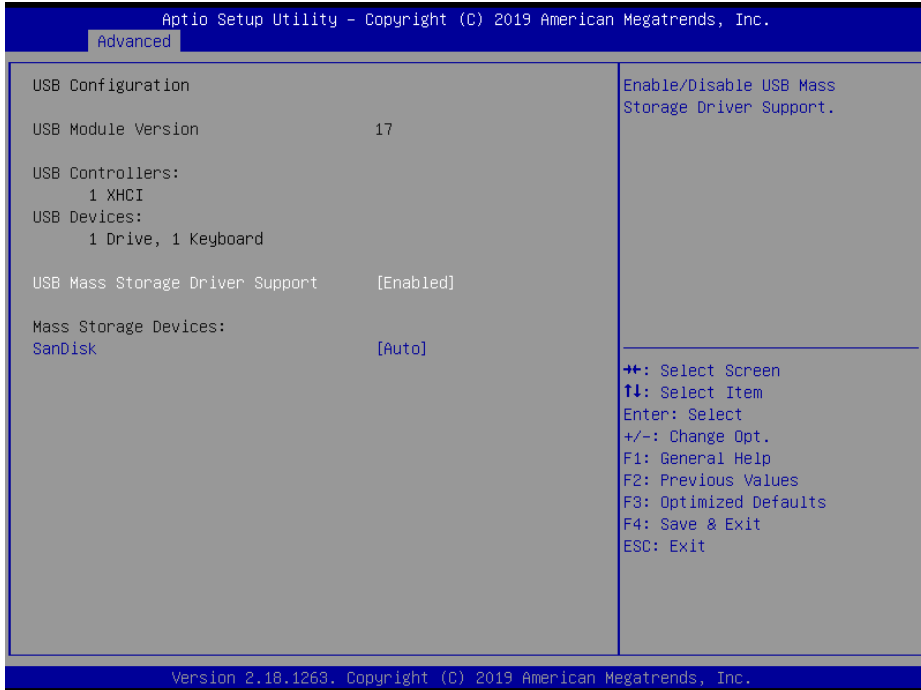

### USB Configuration Screen

BIOS Setting	Options	Description/Purpose
USB Module Version	No changeable options	Displays USB module version.
USB Controllers	No changeable options	Displays number and type of USB controllers (if any).
USB Devices	No changeable options	Displays number and type of connected USB devices (if any).
USB Mass Storage Driver Support	-Disabled -Enabled (default)	Enables/ Disables USB Mass Storage Driver Support.
MASS STORAGE DEVICES: [drive(s)]	-Auto (default) -Floppy -Forced FDD -Hard Disk -CD-ROM	<b>AUTO</b> enumerates devices according to their media format. Optical drives are emulated as 'CD-ROM', drives with no media will be emulated according to a drive type.

## 5.4.9 Chipset

Menu Path *Chipset*

This menu allows users to configure advanced Chipset settings such as North Bridge and South Bridge configuration parameters.

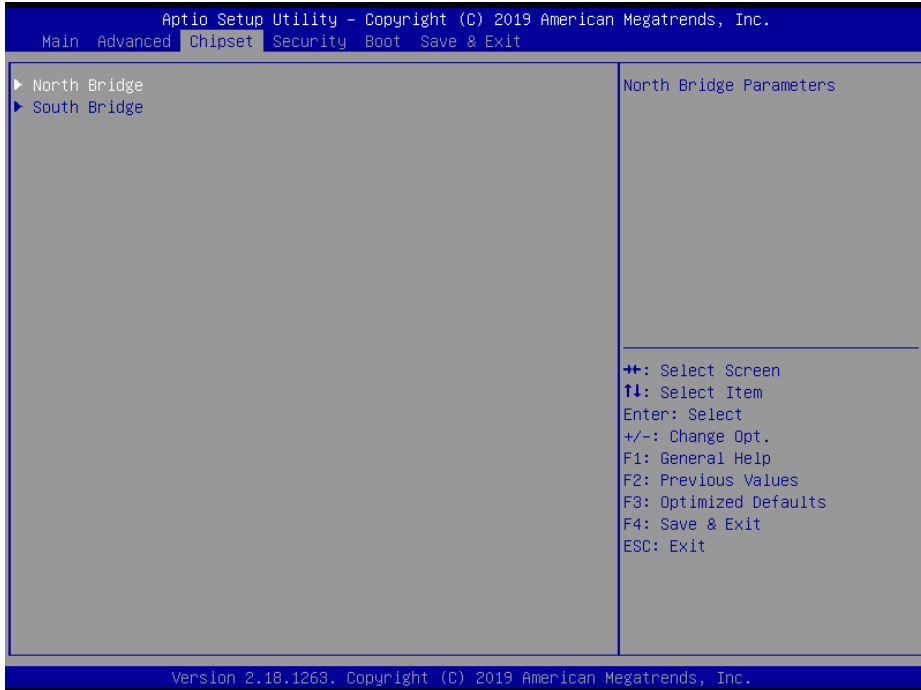

**Chipset Screen**

BIOS Setting	Options	Description/Purpose
North Bridge	Sub-Menu	North Bridge Parameters.
South Bridge	Sub-Menu	South Bridge Parameters.

5.4.9.1 Chipset – North Bridge

Menu Path *Chipset > North Bridge*

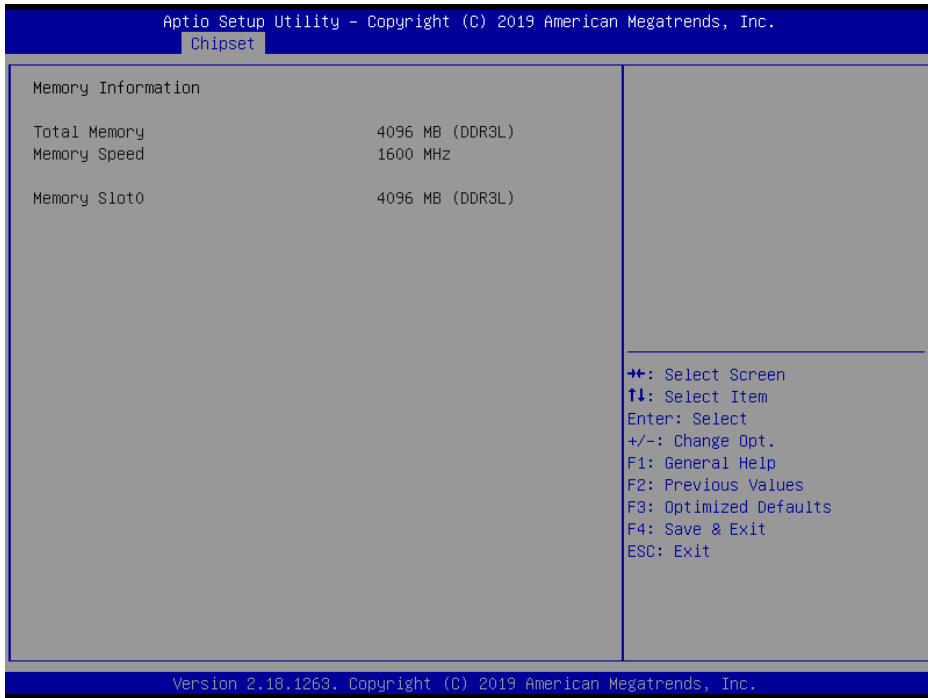

North Bridge Screen

BIOS Setting	Options	Description/Purpose
Total Memory	No changeable options	Displays the current amount and type of memory on the system, e.g. "8192 MB (LPDDR3)".
Memory Speed	No changeable options	Displays the memory speed.
Memory Slot0	No changeable options	Displays the current amount and type of memory on each memory slot, e.g. "8192 MB (LPDDR3)".

5.4.9.2 Chipset – South Bridge

Menu Path *Chipset > South Bridge*

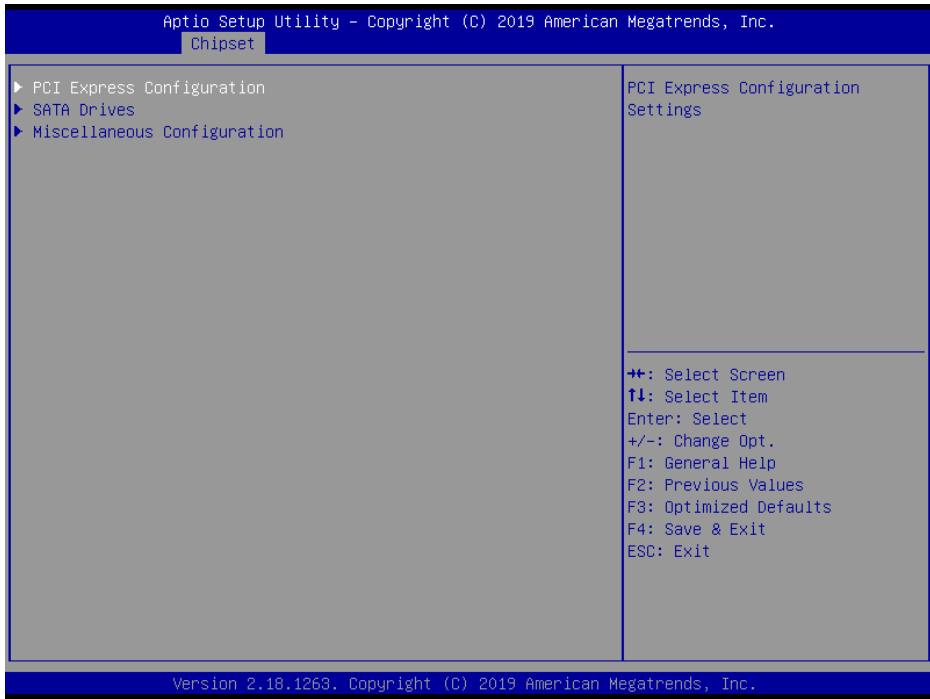

South Bridge Screen

BIOS Setting	Options	Description/Purpose
PCI Express Configuration	Sub-Menu	PCI Express Configuration Settings.
SATA Drives	Sub-Menu	SATA Device Configuration Settings.
Miscellaneous Configuration	Sub-Menu	Miscellaneous Configuration Settings.



5.4.9.3 Chipset – South Bridge – PCI Express Configuration

Menu Path *Chipset > South Bridge > PCI Express Configuration*

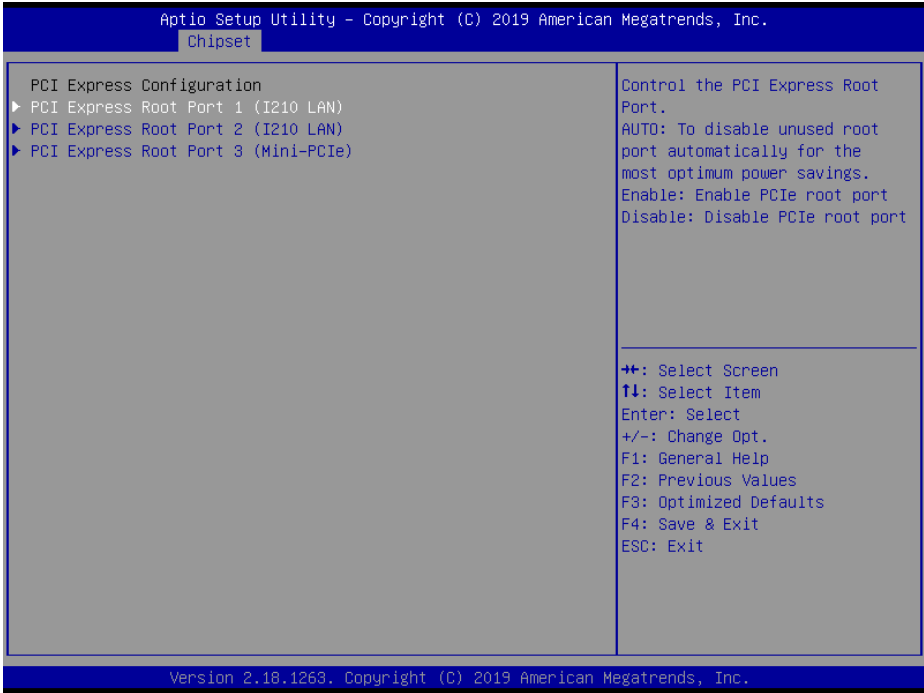

**PCI Express Configuration Screen**

BIOS Setting	Options	Description/Purpose
PCI Express Root Port 1 (I210 LAN)	Sub-Menu	PCI Express Root Port 1 (I210 LAN) parameters.
PCI Express Root Port 2 (I210 LAN)	Sub-Menu	PCI Express Root Port 2 (I210 LAN) parameters.
PCI Express Root Port 3 (Mini-PCIE)	Sub-Menu	PCI Express Root Port 3 (Mini-PCIE) parameters.

Menu Path *Chipset > South Bridge > PCI Express Configuration > PCI Express Root Port 1 (I210 LAN)*

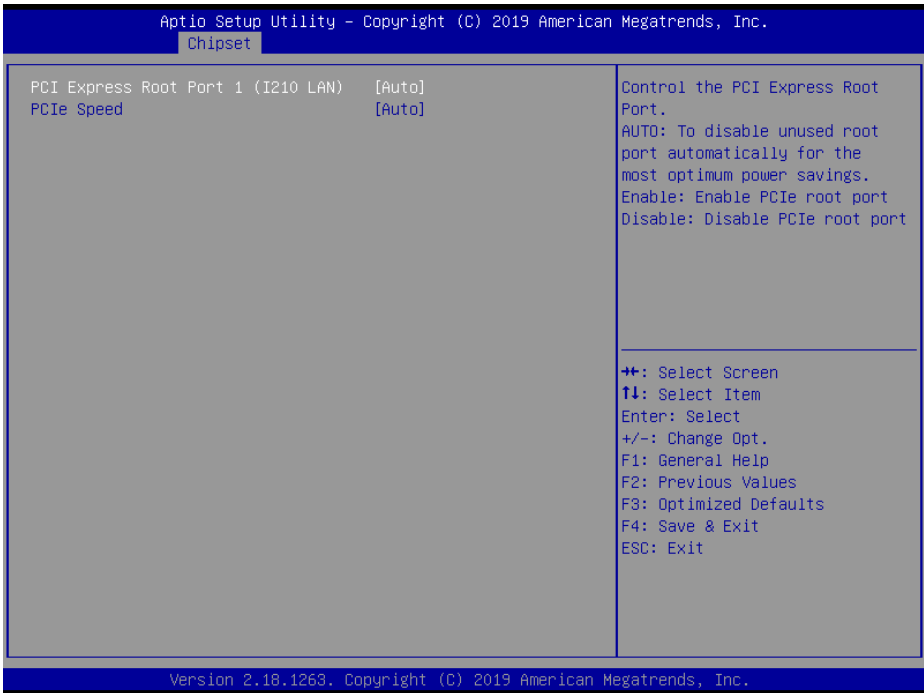

**PCI Express Root Port 1 (I210 LAN) Configuration Screen**

BIOS Setting	Options	Description/Purpose
PCI Express Root Port 1 (I210 LAN)	- Disabled - Enabled - Auto (default)	Enables or Disables PCI Express Root Port 1 (I210 LAN). <ul style="list-style-type: none"> <li>• <b>Auto:</b> Disables the unused Root Port automatically for saving the most optimum power.</li> <li>• <b>Enabled:</b> Enables PCI Express Root Port 1 (I210 LAN).</li> <li>• <b>Disabled:</b> Disables PCI Express Root Port 1 (I210 LAN).</li> </ul>
PCIe Speed	- Auto (default) - Gen1 - Gen2	Configures PCIe speed.

Menu Path *Chipset > South Bridge > PCI Express Configuration > PCI Express Root Port 2 (I210 LAN)*

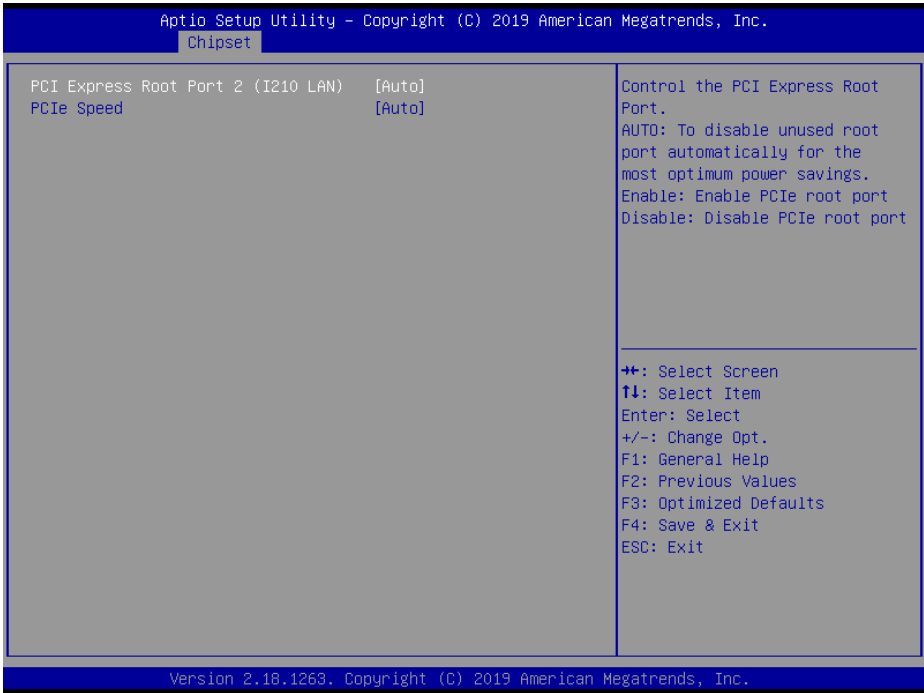

**PCI Express Root Port 2 (I210 LAN) Configuration Screen**

BIOS Setting	Options	Description/Purpose
PCI Express Root Port 2 (I210 LAN)	- Disabled - Enabled - Auto (default)	Enables or Disables PCI Express Root Port 2 (I210 LAN). <ul style="list-style-type: none"> <li>• <b>Auto:</b> Disables the unused Root Port <b>automatically</b> for saving the most optimum power.</li> <li>• <b>Enabled:</b> Enables PCI Express Root Port 2 (I210 LAN).</li> <li>• <b>Disabled:</b> Disables PCI Express Root Port 2 (I210 LAN).</li> </ul>
PCIe Speed	- Auto (default) - Gen1 - Gen2	Configures PCIe speed.

Menu Path *Chipset > South Bridge > PCI Express Configuration > PCI Express Root Port 3 (Mini-PCIe)*

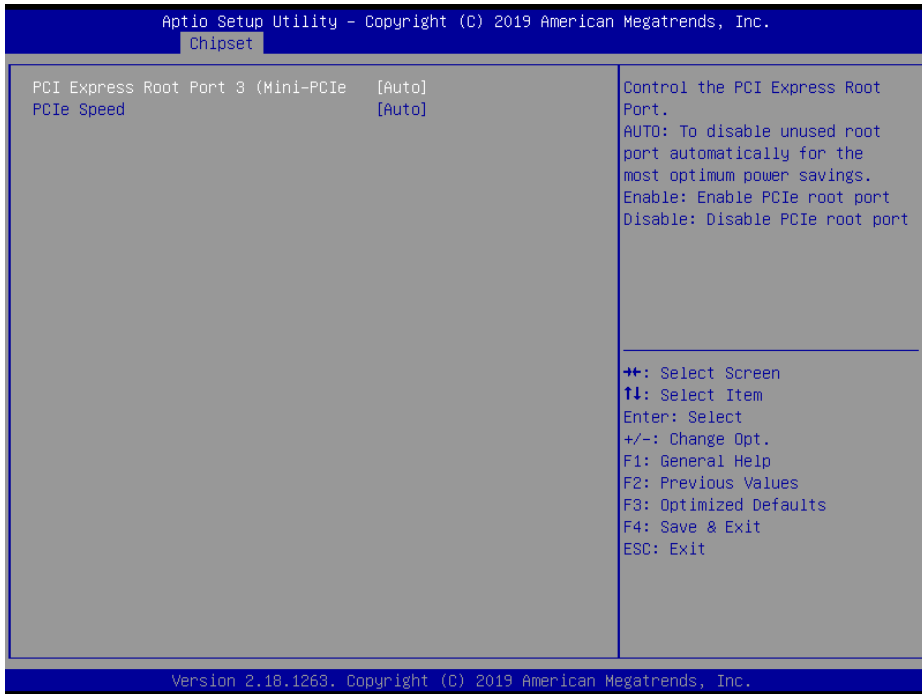

**PCI Express Root Port 3 (Mini-PCIe) Configuration Screen**

BIOS Setting	Options	Description/Purpose
PCI Express Root Port 3 (Mini-PCIe)	- Disabled - Enabled - Auto (default)	Enables or Disables PCI Express Root Port 3 (Mini-PCIe). <ul style="list-style-type: none"> <li>• <b>Auto:</b> Disables the unused Root Port <b>automatically</b> for saving the most optimum power.</li> <li>• <b>Enabled:</b> Enables PCI Express Root Port 3 (Mini-PCIe).</li> <li>• <b>Disabled:</b> Disables PCI Express Root Port 3 (Mini-PCIe).</li> </ul>
PCIe Speed	- Auto (default) - Gen1 - Gen2	Configures PCIe speed.

5.4.9.4 Chipset – South Bridge – SATA Drives

Menu Path *Chipset > South Bridge > SATA Drives*

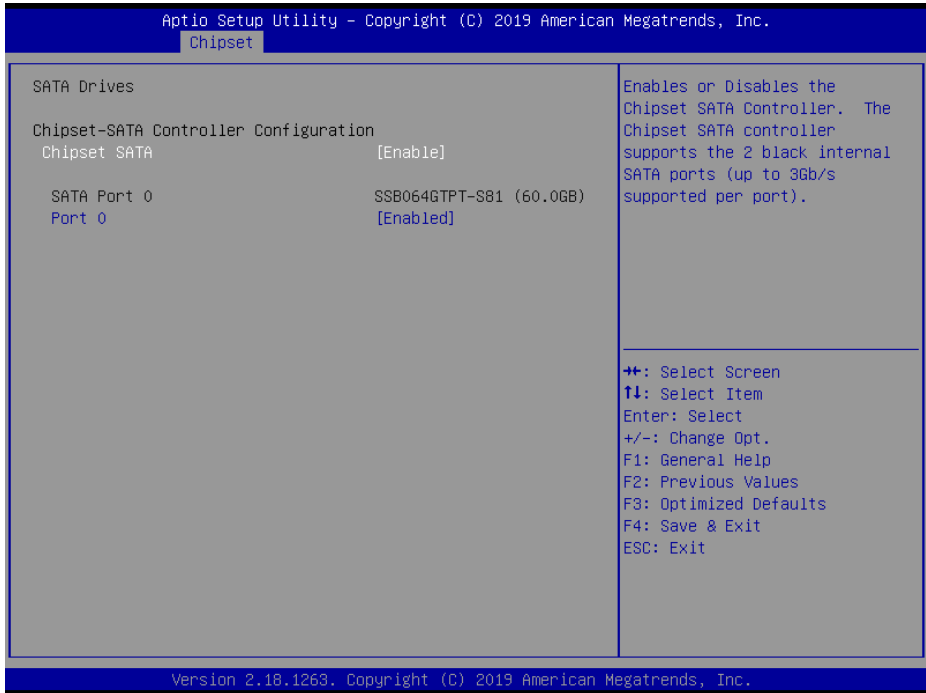

SATA Drives Screen

BIOS Setting	Options	Description/Purpose
Chipset SATA	- Disabled - Enabled (default)	Enables or Disables the Chipset SATA Controller.
SATA Port 0	No changeable options	Displays SATA drive branding information if the device exists on port 0.
Port 0	- Disabled - Enabled (default)	Enables or Disables SATA Port 0.

5.4.9.5 Chipset – South Bridge – Miscellaneous Configuration

Menu Path *Chipset > South Bridge > Miscellaneous Configuration*

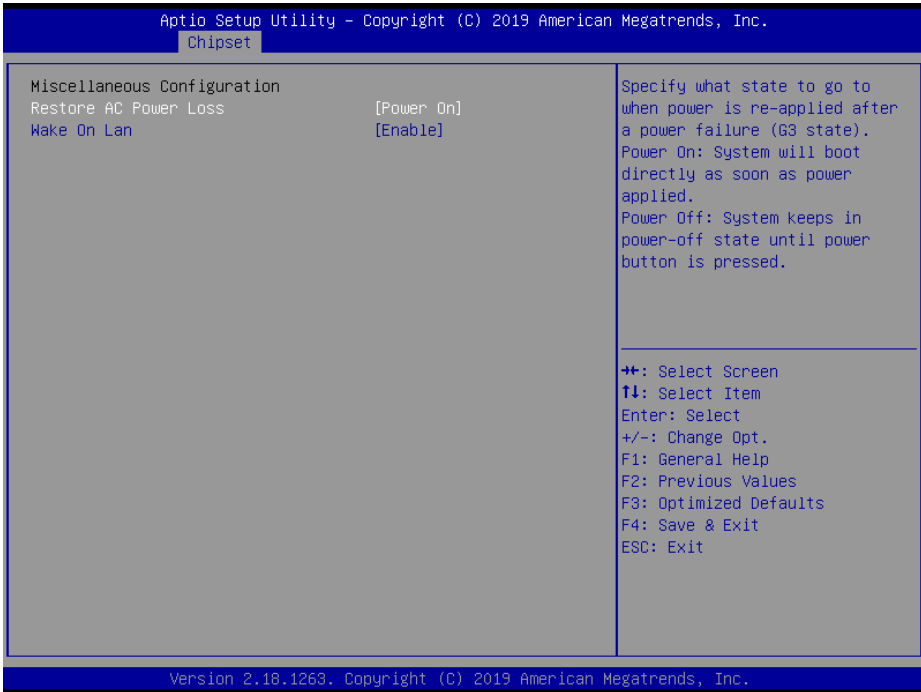

Miscellaneous Configuration Screen

BIOS Setting	Options	Description/Purpose
Restore AC Power Loss	- Power On (default) - Power Off	Specifies what state to go to when AC power is re-applied after power failure (G3 state). <ul style="list-style-type: none"> <li><b>Power On:</b> System will boot directly as soon as the AC Power is applied.</li> <li><b>Power Off:</b> System keeps in power-off state until the Power button is pressed.</li> </ul>
Wake On Lan	- Disabled - Enabled (default)	Enables or Disables the Wake on Lan (WOL).  Win 8/8.1/10 doesn't support WOL from hybrid shutdown state (S4). If users need WOL from classic shutdown state (S5), please turn off 'fast startup' feature in OS.

## 5.5 Security

Menu Path                      *Security*

From the **Security** menu, you are allowed to create, change or clear the administrator password. You will be asked to enter the configured administrator password before you can access the Setup Utility.

By setting an administrator password, you will prevent other users from changing your BIOS settings. You can configure an Administrator password and then configure a user password. An administrator has much more privileges over the settings in the Setup utility than a user. Heed that a user password does not provide access to most of the features in the Setup utility.

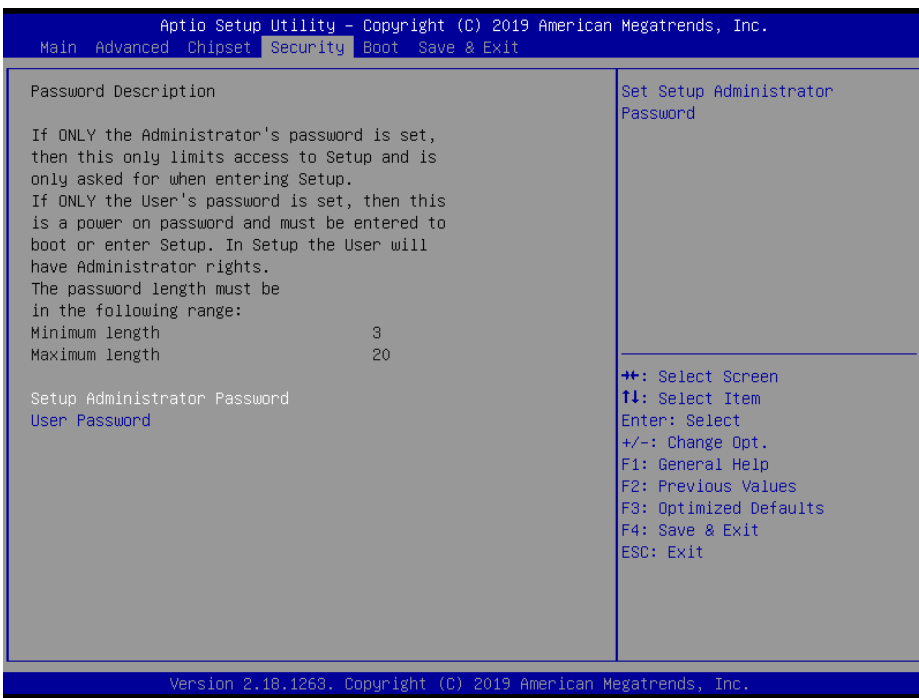

### Security Screen

BIOS Setting	Options	Description/Purpose
Setup Administrator Password	Password can be 3-20 alphanumeric characters.	Specifies the administrator password.
User Password	Password can be 3-20 alphanumeric characters.	Specifies the user password.

**Create an Administrator or User Password**

1. Select the **Administrator Password / User Password** option from the Security menu and press <Enter>, and the password dialog entry box appears.
2. Enter the password you want to create. A password can be 3-20 alphanumeric characters. After you have configured the password, press <Enter> to confirm.
3. Type the new password again and press <Enter>.

**Change an Administrator or User Password**

1. Select the **Administrator Password / User Password** option from the Security menu and press <Enter>, and the password dialog entry box appears.
2. Select the Administrator Password or User Password that you want to change. A password can be 3-20 alphanumeric characters. After you have changed the password, press <Enter> to confirm.
3. Type the changed password again and press <Enter>.

**Remove an Administrator or User Password**

1. Select the **Administrator Password / User Password** option from the Security menu and press <Enter>, and the password dialog entry box appears.
2. Select the configured Administrator Password or User Password that you want to delete. Leave the dialog box blank and press <Enter>.
3. Press <Enter> again when the password confirmation box appears.



## 5.6 Boot

### Menu Path                      Boot

This menu provides control items for system boot configuration such as setting setup prompt timeout, enabling/disabling quiet boot and fast boot, and changing the boot order from the available bootable device(s).

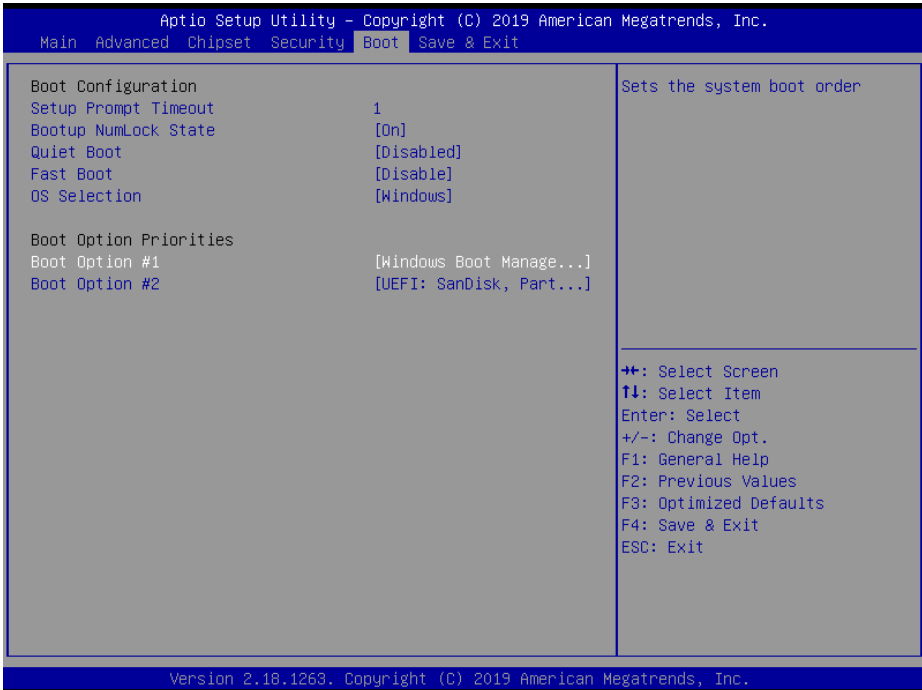

**Boot Screen**

BIOS Setting	Options	Description/Purpose
Setup Prompt Timeout	Numeric (from 1 to 65535)	Number of seconds to wait for setup activation key.
Bootup NumLock State	- On (default) - Off	Selects the NumLock state after the system is powered on. <ul style="list-style-type: none"> <li>• <b>On:</b> Enables the NumLock function automatically after the system is powered on.</li> <li>• <b>Off:</b> Disables the NumLock function after the system is powered on.</li> </ul>

<b>BIOS Setting</b>	<b>Options</b>	<b>Description/Purpose</b>
Quiet Boot	- Disabled (default) - Enabled	Enables or Disables Quiet Boot options. When this option is set to “Enabled”, BIOS will display AMI or OEM logo (if implemented) instead of POST messages during the boot..
Fast Boot	- Disabled (default) - Enabled	Enables or Disables Fast Boot option. It allows users to reduce the system startup time and start up the system in a fast manner.
OS Selection	-Windows (default) -Intel Linux	Selects the target OS.
Boot Option #1~#n	- [Drive(s)] - Disabled	Allows users to change the boot order from the available device(s). Note that in the menu displayed, you will only see the device with the highest priority for a specific boot device type.

## 5.7 Save & Exit

Menu Path *Save & Exit*

The **Save & Exit** allows users to save or discard changed BIOS settings as well as load factory default settings.

### Save Changed BIOS Settings

To save and validate the changed BIOS settings, select **Save Changes** from the **Save & Exit** menu, or you can select **Save Changes and Exit** (or press **F4**) to validate the changes and then exit the system. Select **Save Changes and Reset** to validate the changed BIOS settings and then restart the system

### Discard Changed BIOS Settings

To cancel the BIOS settings you have previously configured, select **Discard Changes and Exit** from this menu, or simply press **Esc** to exit the BIOS setup. You can also select **Discard Changes and Reset** to discard any changes you have made and restore the factory BIOS defaults.

### Load User Defaults

You may simply press **F3** at any time to load the **Optimized Values** which resets all BIOS settings to the factory defaults.

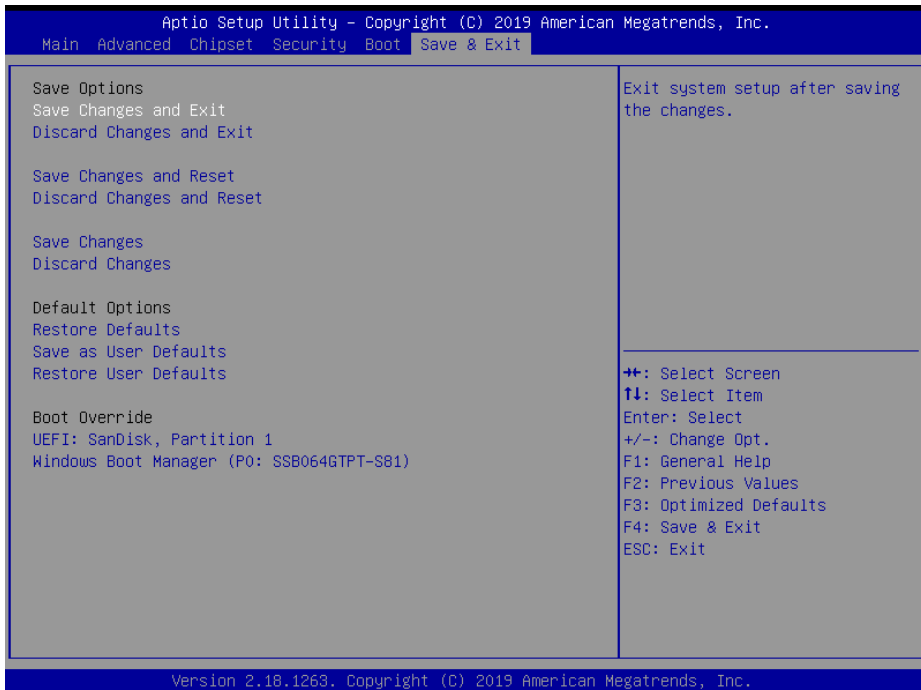

Save & Exit Screen

<b>BIOS Setting</b>	<b>Options</b>	<b>Description/Purpose</b>
Save Changes and Exit	No changeable options	Exits and saves the changes in NVRAM.
Discard Changes and Exit	No changeable options	Exits without saving any changes made in BIOS settings.
Save Changes and Reset	No changeable options	Saves the changes in NVRAM and resets.
Discard Changes and Reset	No changeable options	Resets without saving any changes made in BIOS settings.
Save Changes	No changeable options	Saves changes done so far to any of the setup options.
Discard Changes	No changeable options	Discards Changes done so far to any of the setup options.
Restore Defaults	No changeable options	Loads the optimized defaults for BIOS settings.
Save as User Defaults	No changeable options	Saves the changes done so far as User Defaults.
Restore User Defaults	No changeable options	Restores the User Defaults to all the setup options.
Boot Override	- [Drive(s)]	Forces to boot from selected [drive(s)].



# Appendix A System Diagrams

---

---

This appendix includes the exploded diagrams of the system and the parts list as well as the part numbers of the SG-S151 / SG-S171 / SG-S211 system.

- SG-S151 System Exploded Diagram
- SG-S171 System Exploded Diagram
- SG-S211 System Exploded Diagram
- VESA Mount Assembly Exploded Diagram
- Stand Kit Assembly Exploded Diagram
- SG-S151 Packing Exploded Diagram
- SG-S171 Packing Exploded Diagram
- SG-S211 Packing Exploded Diagram

**SG-S151 System Exploded Diagram**

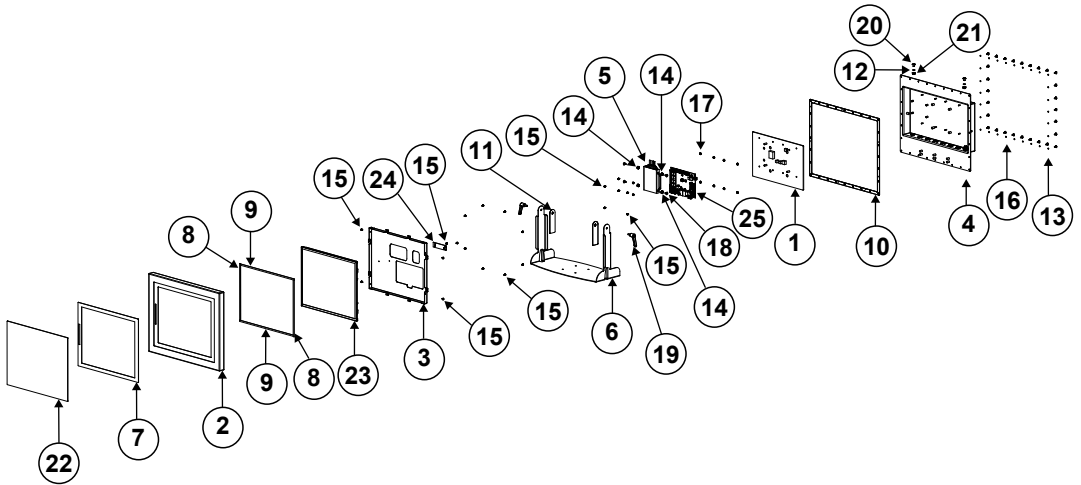

No.	Component Name	P/N No.	Q'ty
1	SG-S151 AL Heat Sink 986 (300x190x3mm)	21-002-10090001	1
Metal (Bracket)			
2	SG-S151 Front Cover Bracket	20-106-07001467	1
3	SG-S151 LCD Bracket	20-106-03001467	1
4	SG-S151 Rear Cover Bracket	20-106-07002467	1
5	SG-S151 HDD Bracket	20-106-03002467	1
6	SG-S151 U STAND	20-117-07001467	1
Rubber / Tape			
7	SG-S151 VHB A2308 Touch Tape (358x272.5x0.8mm)	34-026-05001467	1
8	SP-7755 LCD STRIPS RL (243.3x5.3x0.85mm)	30-013-24100426	2
9	SP-7755 LCD STRIPS TB (317.95x5.3x0.85mm)	30-013-24200426	2
10	SG-S151 Rear Waterproof Silicon Rubber (414x329x1mm)	90-013-01100467	1
11	SG-S151 Stand Mylar (OD= $\varphi$ 15mm, ID= $\varphi$ 8mmx1T)	90-056-39100467	2
12	O-Ring (Black)	30-013-06500000	2
13	SP-7755 Screw O Ring	90-013-06100426	28
14	Rubber Washer (OD= $\varphi$ 9.62mm, ID= $\varphi$ 3.9mmx5.8T) (Blue)	23-680-39580963	4
Screw / Other Component			
15	Round Head With Spring Washer Screw M3x0.5Px6mm	22-232-30060211	22
16	Fillister Head Screw #2 / M3x0.5Px7mm	22-270-30007011	28
17	SLIP NUTS(M3x0.5P,H=4mm)	23-142-30400801	8

**Appendix A System Diagrams**

<b>No.</b>	<b>Component Name</b>	<b>P/N No.</b>	<b>Q'ty</b>
18	Fillister Head Screw M3x0.5Px4.8mm	82-272-30005013	4
19	Adjustable Hand Levers	20-035-35001000	2
20	Truss Head Screw (SUS304) #3 / M6x1.0Px8mm	22-240-60008011	2
21	Slip Nuts (M6x1.0P,H=6mm)	23-142-60601271	2
22	15" 5-Wire Resistive Touch Panel	52-380-00052417	1
	15" Projected Capacitive Touch Panel	52-380-00150517	1
23	LCD Panel	52-351-03016802	1
24	Touch Control Board (available for -Wire Resistive Touch Panel)	52-370-01040504	1
25	BE-0986 Main Board	BE-0986RB-M4N / BE-0986RB-G1N / BE-0986RB-J0N	1



**SG-S171 System Exploded Diagram**

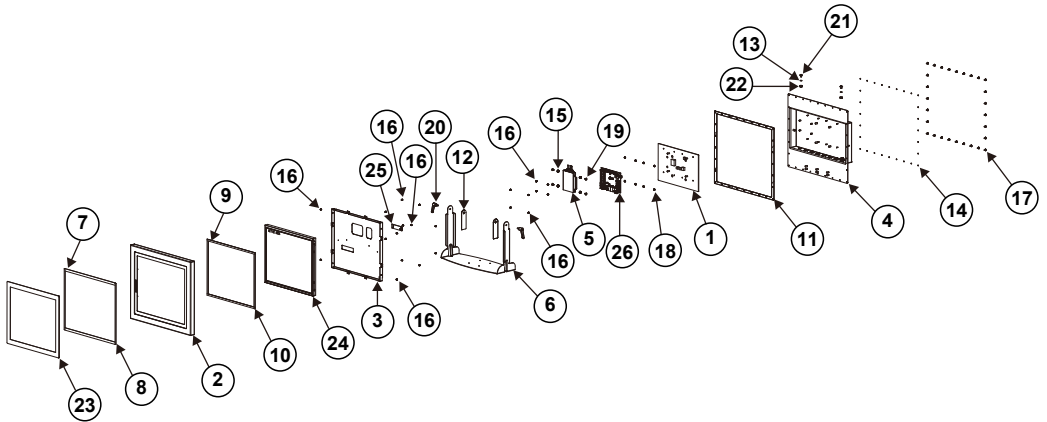

No.	Component Name	P/N No.	Q'ty
1	SG-S151 AL Heat Sink 986 (300x190x3mm)	21-002-10090001	1
Metal (Bracket)			
2	SG-S171 Front Cover Bracket	20-106-07002486	1
3	SG-S171 LCD Bracket	80-106-03001486	1
4	SG-S171 Rear Cover Bracket	20-106-07001486	1
5	SG-S151 HDD Bracket	20-106-03002467	1
6	SG-S171 U Stand	20-217-07001486	1
Rubber / Tape			
7	SP-7147 ABON A-15170-1452 EPDM-H (386.92x30x0.8mm)	34-026-06201412	2
8	SP-7147 ABON A-15170-1452 EPDM-V (271.24x18x0.8mm)	34-026-06202412	2
9	ST-2017 Thin Gap LCD Poron-H (358x8x1mm)	30-013-24100366	2
10	ST-2017 Thin GAP LCD Poron-V (274x8x1mm)	30-013-24200366	2
11	SG-S171 Rear Waterproof Silicon Rubber	30-013-01100486	1
12	SG-S151 Stand Mylar	90-056-39100467	2
13	O-Ring (Black)	30-013-06500000	2
14	SP-7755 Screw O Ring	90-013-06100426	28
15	Rubber Washer (OD= $\varphi$ 9.62mm, ID= $\varphi$ 3.9mmx5.8T) (Blue)	23-680-39580963	4
Screw / Other Component			
16	Round Head With Spring Washer Screw M3x0.5Px6mm	22-232-30060211	22
17	Fillister Head Screw #2 / M3x0.5Px7mm	22-270-30007011	28

**Appendix A System Diagrams**

<b>No.</b>	<b>Component Name</b>	<b>P/N No.</b>	<b>Q'ty</b>
18	SLIP NUTS(M3x0.5P,H=4mm)	23-142-30400801	8
19	Fillister Head Screw M3x0.5Px4.8mm	82-272-30005013	4
20	Adjustable Hand Levers	20-035-35001000	2
21	Truss Head Screw (SUS304) #3 / M6x1.0Px8mm	22-240-60008011	2
22	Slip Nuts (M6x1.0P,H=6mm)	23-142-60601271	2
23	17" 5-Wire Resistive Touch Panel	52-380-04211114	1
	17" P-CAP Touch Panel	52-380-04381714	1
24	17" TFT LCD Panel(LED Backlight),350nits, SXGA (1280x1024)	52-351-04017002	1
25	Touch Control Board (available for -Wire Resistive Touch Panel)	52-370-01405104	1
26	BE-0986 Main Board	BE-0986RB-G1N / BE-0986RB-J0N	1

**SG-S211 System Exploded Diagram**

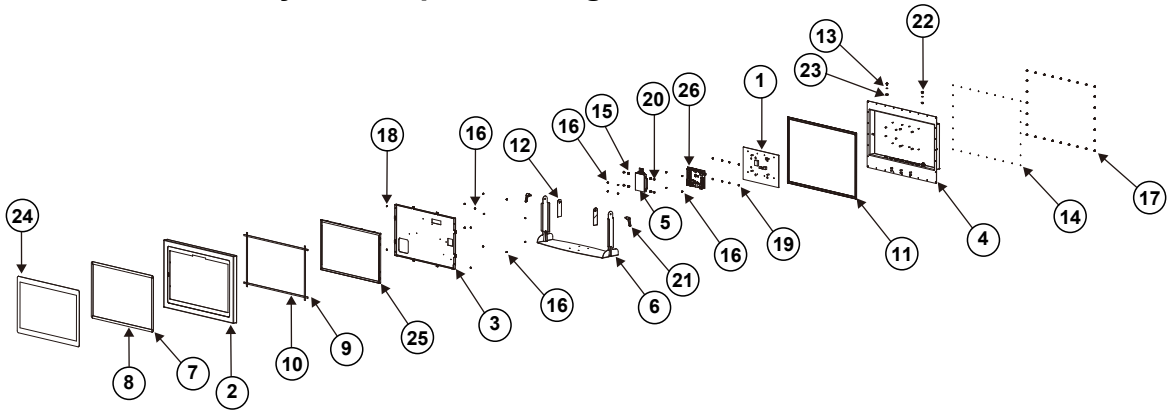

No.	Component Name	P/N No.	Q'ty
1	SG-S151 AL Heat Sink 986 (300x190x3mm)	21-002-10090001	1
Metal (Bracket)			
2	SG-S211 Front Cover Bracket	20-106-07001479	1
3	SG-S211 LCD Bracket	80-106-03001479	1
4	SG-S211 Rear Cover Bracket	20-106-07002479	1
5	SG-S151 HDD Bracket	20-106-03002467	1
6	SG-S211 U Stand	20-217-07001479	1
Rubber / Tape			
7	KS-1132 Touch Panel VHB ELO-S (332x14x1mm)	34-026-05002450	2
8	KS-1132 Touch Panel VHB ELO-L (503x14x1mm)	34-026-05001450	2
9	SP-S214 Touch Thin Gap EPDM V (318x7x2mm)	30-013-01100454	2
10	SP-S214 Touch Thin Gap EPDM H (540x7x2mm)	30-013-01200454	2
11	SG-S211 Rear Waterproof Silicon Rubber (584x389x1mm)	30-013-01100479	1
12	SG-S151 Stand Mylar	90-056-39100467	2
13	O-Ring (Black)	30-013-06500000	2
14	SP-7755 Screw O Ring	90-013-06100426	28
15	Rubber Washer (OD= $\varphi$ 9.62mm, ID= $\varphi$ 3.9mmx5.8T) (Blue)	23-680-39580963	4
Screw / Other Component			
16	Round Head With Spring Washer Screw M3x0.5Px6mm	22-232-30060211	22
17	Fillister Head Screw #2 / M3x0.5Px7mm	22-270-30007011	28
18	Round Washer Head Screw #2 / M3x0.5Px3mm	22-235-30003011	4
19	SLIP NUTS(M3x0.5P,H=4mm)	23-142-30400801	8
20	Fillister Head Screw M3x0.5Px4.8mm	82-272-30005013	4

**Appendix A System Diagrams**

<b>No.</b>	<b>Component Name</b>	<b>P/N No.</b>	<b>Q'ty</b>
21	Adjustable Hand Levers	20-035-35001000	2
22	Truss Head Screw (SUS304) #3 / M6x1.0Px8mm	22-240-60008011	2
23	Slip Nuts (M6x1.0P,H=6mm)	23-142-60601271	2
24	21.5" 5-Wire Resistive Touch Panel	N/A	1
	21.5" Capacitive Touch Panel	52-380-13795701	1
25	21.5" TFT LCD Panel(LED Backlight),350nits(1920x1080)	52-351-13215202	1
26	BE-0986 Main Board	BE-0986RB-J0N	1

**VESA Mount Installation Exploded Diagram**

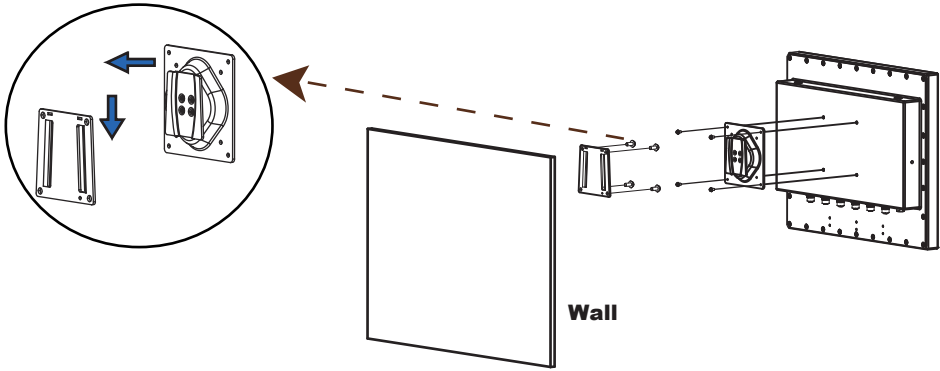

## Stand Kit Installation Exploded Diagram

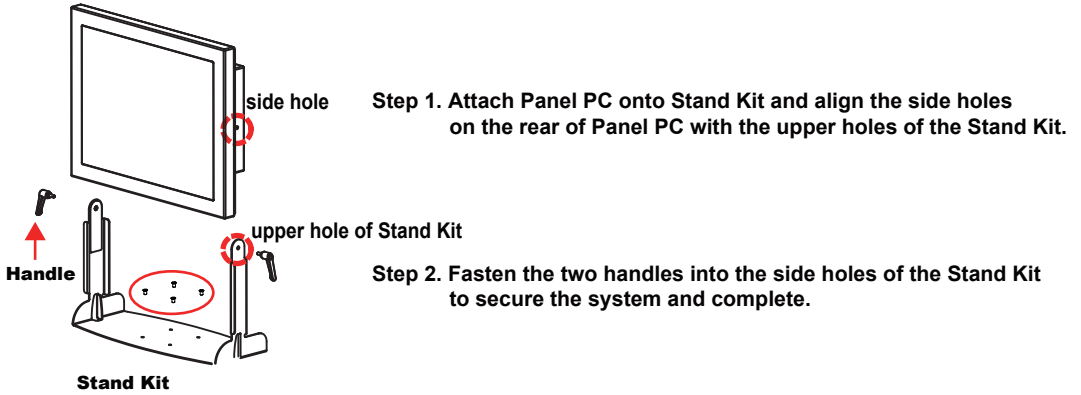

### Stand Installation Accessories

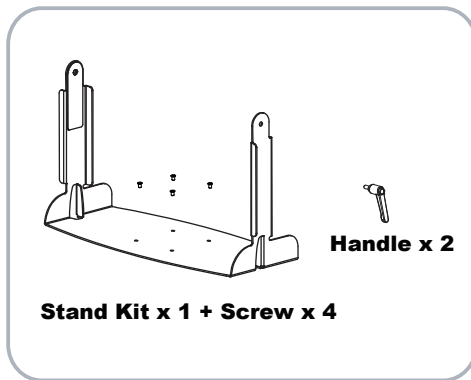

### SG-S151 Packing Exploded Diagram

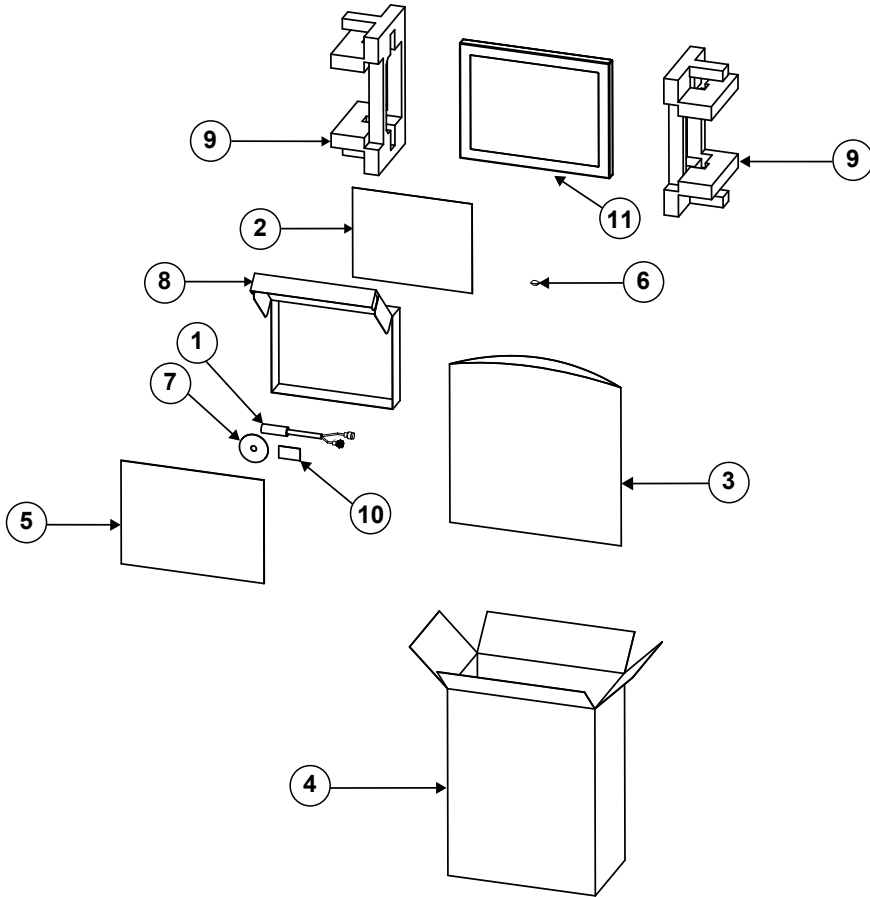

No.	Component Name	P/N No.	Q'ty
1	SP-7755 Power Cable ( L=1800mm)	27-019-42636111	1
2	Mylar 335x260x0.125mm	30-056-02100008	1
3	PE Bag 480X460 (42X56CMx0.07)	32-10020010000	1
4	MH-5100-VR Plastic Box Outer Carton (543x413x243mm)	34-001-01401378	1
5	Card Board (400x300)	34-004-01301008	1
6	Silica Gel1gm	34-005-00010007	2
7	DVD-R(w/Protech logo) For OBM	52-601-02000005	1
8	PT-1920 Carton Boxes (340x278x60mm)	94-003-01301318	1
9	SG-S151 EPE (397x218x133mm)	94-016-00301467	2
10	SG-S151 Rating Label (60x35mm)	94-017-01601467	1
11	SG-S151	N/A	1

**SG-S171 Packing Exploded Diagram**

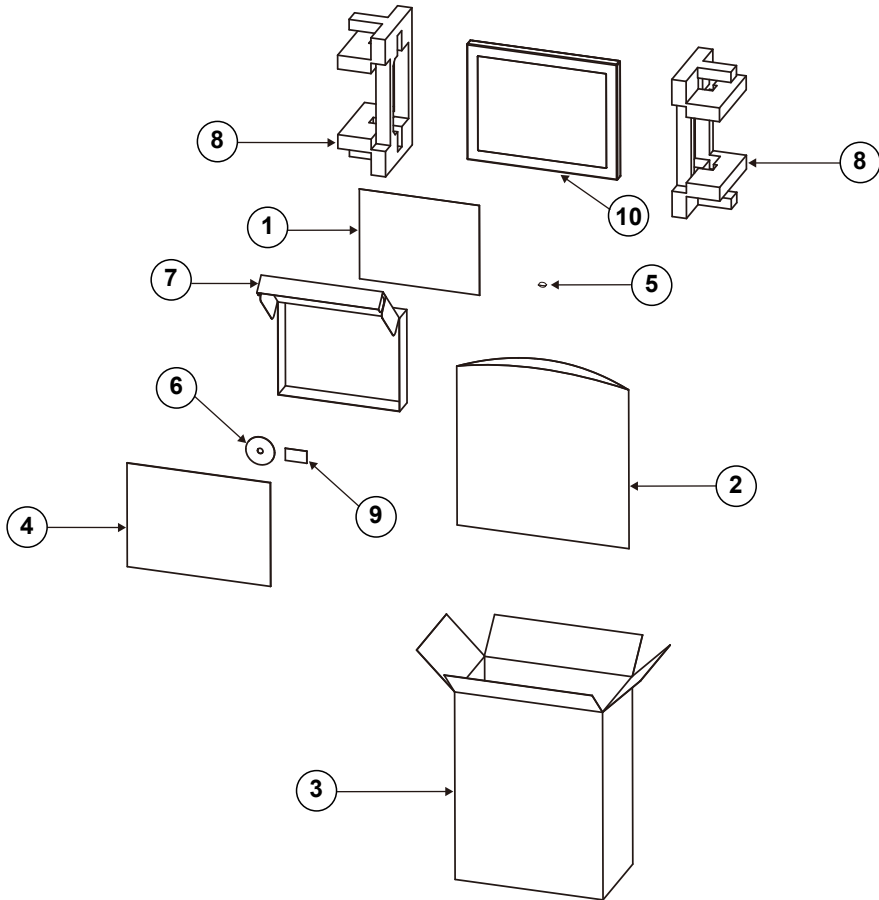

No.	Component Name	P/N No.	Q'ty
1	Mylar 335x260x0.125	30-056-02100008	1
2	PE Bag 870x670x0.07mm	34-010-00210003	1
3	MM-7017R Basic Style Outer Carton (532x487x203mm)	94-001-01401258	1
4	Card Board (400x300)	34-004-01301008	1
5	SILICA GEL 1gm	34-005-00010007	2
6	DVD-R (w/Protech logo) For OBM	52-601-02000005	1
7	PT-1920 Carton Boxes (340x278x60mm)	94-003-01301318	1
8	SG-S171 PPC EPE (475x185x192mm)	94-016-00304486	2
9	Electroforming Paster ("Prox" Logo L)	34-017-02201000	1
10	SG-S171	N/A	1



**SG-S211 Packing Exploded Diagram**

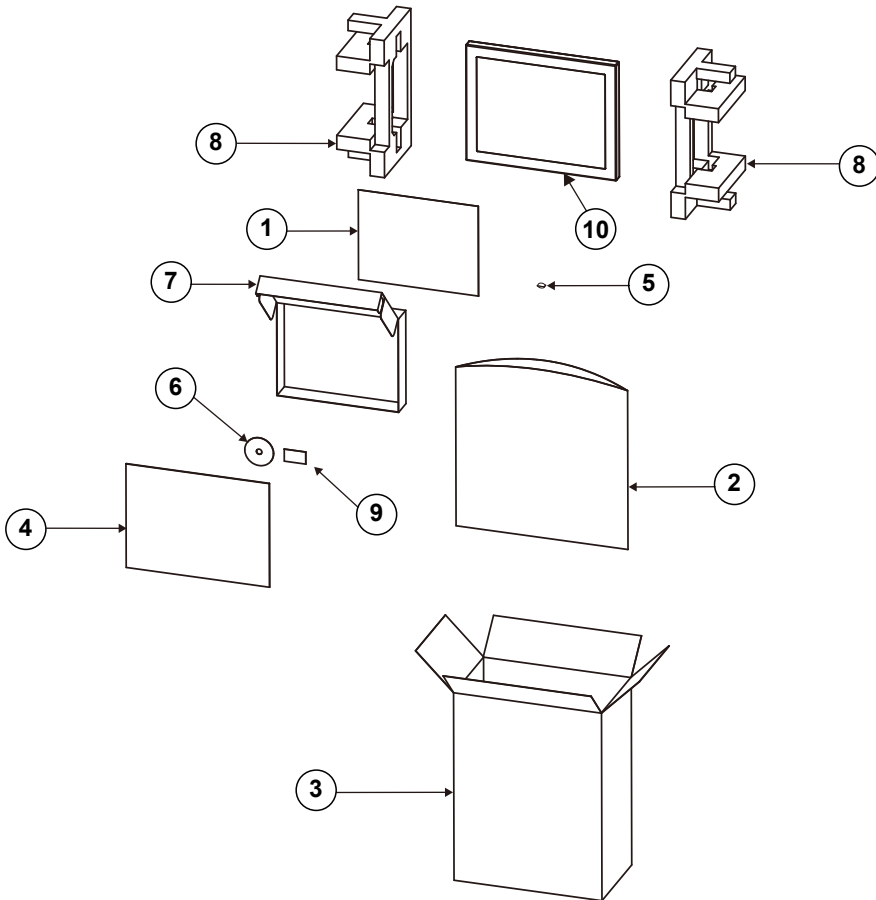

No.	Component Name	P/N No.	Q'ty
1	Mylar 335x260x0.125	30-056-02100008	1
2	PE Bag 870x670x0.07mm	34-010-00210003	1
3	SG-S211 Outer Carton (680x490x200mm)	94-001-01401479	1
4	Card Board (400x300)	34-004-01301008	1
5	SILICA GEL 1gm	34-005-00010007	2
6	DVD-R (w/Protech logo) For OBM	52-601-02000005	1
7	PT-1920 Carton Boxes (340x278x60mm)	94-003-01301318	1
8	SG-S211 PPC EPE (475x185x192mm)	94-016-00304479	2
9	Electroforming Paster ("Prox" Logo L)	34-017-02201000	1
10	SG-S211	N/A	1

## **Appendix B Technical Summary**

---

---

This appendix will give you a brief introduction of the allocation maps for the system resources.

The following topics are included:

- BE-0986 Block Diagram
- Interrupt Map
- I/O Map
- Memory Map
- Configuring WatchDog Timer
- Flash BIOS Update

# BE-0986 Block Diagram

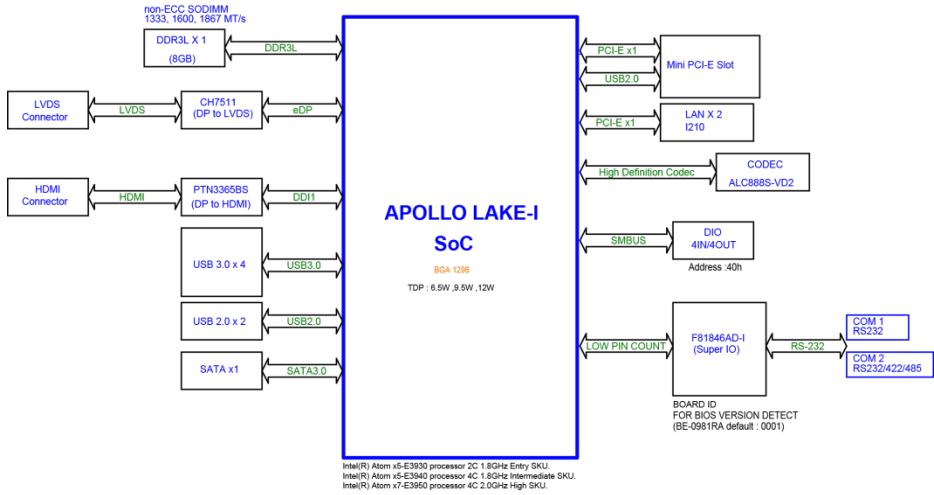

**Interrupt Map**

<b>IRQ</b>	<b>Assignment</b>
IRQ 0	System timer
IRQ 3	Communications Port (COM2)
IRQ 8	System CMOS/real time clock
IRQ 54	Microsoft ACPI-Compliant System
IRQ 55	Microsoft ACPI-Compliant System
IRQ 56	Microsoft ACPI-Compliant System
IRQ 57	Microsoft ACPI-Compliant System
IRQ 58	Microsoft ACPI-Compliant System
IRQ 59	Microsoft ACPI-Compliant System
IRQ 60	Microsoft ACPI-Compliant System
IRQ 61	Microsoft ACPI-Compliant System
IRQ 62	Microsoft ACPI-Compliant System
IRQ 63	Microsoft ACPI-Compliant System
IRQ 64	Microsoft ACPI-Compliant System
IRQ 65	Microsoft ACPI-Compliant System
IRQ 66	Microsoft ACPI-Compliant System
IRQ 67	Microsoft ACPI-Compliant System
IRQ 68	Microsoft ACPI-Compliant System
IRQ 69	Microsoft ACPI-Compliant System
IRQ 70	Microsoft ACPI-Compliant System
IRQ 71	Microsoft ACPI-Compliant System
IRQ 72	Microsoft ACPI-Compliant System
IRQ 73	Microsoft ACPI-Compliant System
IRQ 74	Microsoft ACPI-Compliant System
IRQ 75	Microsoft ACPI-Compliant System
IRQ 76	Microsoft ACPI-Compliant System
IRQ 77	Microsoft ACPI-Compliant System
IRQ 78	Microsoft ACPI-Compliant System
IRQ 79	Microsoft ACPI-Compliant System
IRQ 80	Microsoft ACPI-Compliant System
IRQ 81	Microsoft ACPI-Compliant System
IRQ 82	Microsoft ACPI-Compliant System
IRQ 83	Microsoft ACPI-Compliant System
IRQ 84	Microsoft ACPI-Compliant System

<b>IRQ</b>	<b>Assignment</b>
IRQ 85	Microsoft ACPI-Compliant System
IRQ 86	Microsoft ACPI-Compliant System
IRQ 87	Microsoft ACPI-Compliant System
IRQ 88	Microsoft ACPI-Compliant System
IRQ 89	Microsoft ACPI-Compliant System
IRQ 90	Microsoft ACPI-Compliant System
IRQ 91	Microsoft ACPI-Compliant System
IRQ 92	Microsoft ACPI-Compliant System
IRQ 93	Microsoft ACPI-Compliant System
IRQ 94	Microsoft ACPI-Compliant System
IRQ 95	Microsoft ACPI-Compliant System
IRQ 96	Microsoft ACPI-Compliant System
IRQ 97	Microsoft ACPI-Compliant System
IRQ 98	Microsoft ACPI-Compliant System
IRQ 99	Microsoft ACPI-Compliant System
IRQ 100	Microsoft ACPI-Compliant System
IRQ 101	Microsoft ACPI-Compliant System
IRQ 102	Microsoft ACPI-Compliant System
IRQ 103	Microsoft ACPI-Compliant System
IRQ 104	Microsoft ACPI-Compliant System
IRQ 105	Microsoft ACPI-Compliant System
IRQ 106	Microsoft ACPI-Compliant System
IRQ 107	Microsoft ACPI-Compliant System
IRQ 108	Microsoft ACPI-Compliant System
IRQ 109	Microsoft ACPI-Compliant System
IRQ 110	Microsoft ACPI-Compliant System
IRQ 111	Microsoft ACPI-Compliant System
IRQ 112	Microsoft ACPI-Compliant System
IRQ 113	Microsoft ACPI-Compliant System
IRQ 114	Microsoft ACPI-Compliant System
IRQ 115	Microsoft ACPI-Compliant System
IRQ 116	Microsoft ACPI-Compliant System
IRQ 117	Microsoft ACPI-Compliant System
IRQ 118	Microsoft ACPI-Compliant System
IRQ 119	Microsoft ACPI-Compliant System

<b>IRQ</b>	<b>Assignment</b>
IRQ 120	Microsoft ACPI-Compliant System
IRQ 121	Microsoft ACPI-Compliant System
IRQ 122	Microsoft ACPI-Compliant System
IRQ 123	Microsoft ACPI-Compliant System
IRQ 124	Microsoft ACPI-Compliant System
IRQ 125	Microsoft ACPI-Compliant System
IRQ 126	Microsoft ACPI-Compliant System
IRQ 127	Microsoft ACPI-Compliant System
IRQ 128	Microsoft ACPI-Compliant System
IRQ 129	Microsoft ACPI-Compliant System
IRQ 130	Microsoft ACPI-Compliant System
IRQ 131	Microsoft ACPI-Compliant System
IRQ 132	Microsoft ACPI-Compliant System
IRQ 133	Microsoft ACPI-Compliant System
IRQ 134	Microsoft ACPI-Compliant System
IRQ 135	Microsoft ACPI-Compliant System
IRQ 136	Microsoft ACPI-Compliant System
IRQ 137	Microsoft ACPI-Compliant System
IRQ 138	Microsoft ACPI-Compliant System
IRQ 139	Microsoft ACPI-Compliant System
IRQ 140	Microsoft ACPI-Compliant System
IRQ 141	Microsoft ACPI-Compliant System
IRQ 142	Microsoft ACPI-Compliant System
IRQ 143	Microsoft ACPI-Compliant System
IRQ 144	Microsoft ACPI-Compliant System
IRQ 145	Microsoft ACPI-Compliant System
IRQ 146	Microsoft ACPI-Compliant System
IRQ 147	Microsoft ACPI-Compliant System
IRQ 148	Microsoft ACPI-Compliant System
IRQ 149	Microsoft ACPI-Compliant System
IRQ 150	Microsoft ACPI-Compliant System
IRQ 151	Microsoft ACPI-Compliant System
IRQ 152	Microsoft ACPI-Compliant System
IRQ 153	Microsoft ACPI-Compliant System
IRQ 154	Microsoft ACPI-Compliant System

<b>IRQ</b>	<b>Assignment</b>
IRQ 155	Microsoft ACPI-Compliant System
IRQ 156	Microsoft ACPI-Compliant System
IRQ 157	Microsoft ACPI-Compliant System
IRQ 158	Microsoft ACPI-Compliant System
IRQ 159	Microsoft ACPI-Compliant System
IRQ 160	Microsoft ACPI-Compliant System
IRQ 161	Microsoft ACPI-Compliant System
IRQ 162	Microsoft ACPI-Compliant System
IRQ 163	Microsoft ACPI-Compliant System
IRQ 164	Microsoft ACPI-Compliant System
IRQ 165	Microsoft ACPI-Compliant System
IRQ 166	Microsoft ACPI-Compliant System
IRQ 167	Microsoft ACPI-Compliant System
IRQ 168	Microsoft ACPI-Compliant System
IRQ 169	Microsoft ACPI-Compliant System
IRQ 170	Microsoft ACPI-Compliant System
IRQ 171	Microsoft ACPI-Compliant System
IRQ 172	Microsoft ACPI-Compliant System
IRQ 173	Microsoft ACPI-Compliant System
IRQ 174	Microsoft ACPI-Compliant System
IRQ 175	Microsoft ACPI-Compliant System
IRQ 176	Microsoft ACPI-Compliant System
IRQ 177	Microsoft ACPI-Compliant System
IRQ 178	Microsoft ACPI-Compliant System
IRQ 179	Microsoft ACPI-Compliant System
IRQ 180	Microsoft ACPI-Compliant System
IRQ 181	Microsoft ACPI-Compliant System
IRQ 182	Microsoft ACPI-Compliant System
IRQ 183	Microsoft ACPI-Compliant System
IRQ 184	Microsoft ACPI-Compliant System
IRQ 185	Microsoft ACPI-Compliant System
IRQ 186	Microsoft ACPI-Compliant System
IRQ 187	Microsoft ACPI-Compliant System
IRQ 188	Microsoft ACPI-Compliant System
IRQ 189	Microsoft ACPI-Compliant System

<b>IRQ</b>	<b>Assignment</b>
IRQ 190	Microsoft ACPI-Compliant System
IRQ 191	Microsoft ACPI-Compliant System
IRQ 192	Microsoft ACPI-Compliant System
IRQ 193	Microsoft ACPI-Compliant System
IRQ 194	Microsoft ACPI-Compliant System
IRQ 195	Microsoft ACPI-Compliant System
IRQ 196	Microsoft ACPI-Compliant System
IRQ 197	Microsoft ACPI-Compliant System
IRQ 198	Microsoft ACPI-Compliant System
IRQ 199	Microsoft ACPI-Compliant System
IRQ 200	Microsoft ACPI-Compliant System
IRQ 201	Microsoft ACPI-Compliant System
IRQ 202	Microsoft ACPI-Compliant System
IRQ 203	Microsoft ACPI-Compliant System
IRQ 204	Microsoft ACPI-Compliant System
IRQ 256	Microsoft ACPI-Compliant System
IRQ 257	Microsoft ACPI-Compliant System
IRQ 258	Microsoft ACPI-Compliant System
IRQ 259	Microsoft ACPI-Compliant System
IRQ 260	Microsoft ACPI-Compliant System
IRQ 261	Microsoft ACPI-Compliant System
IRQ 262	Microsoft ACPI-Compliant System
IRQ 263	Microsoft ACPI-Compliant System
IRQ 264	Microsoft ACPI-Compliant System
IRQ 265	Microsoft ACPI-Compliant System
IRQ 266	Microsoft ACPI-Compliant System
IRQ 267	Microsoft ACPI-Compliant System
IRQ 268	Microsoft ACPI-Compliant System
IRQ 269	Microsoft ACPI-Compliant System
IRQ 270	Microsoft ACPI-Compliant System
IRQ 271	Microsoft ACPI-Compliant System
IRQ 272	Microsoft ACPI-Compliant System
IRQ 273	Microsoft ACPI-Compliant System
IRQ 274	Microsoft ACPI-Compliant System
IRQ 275	Microsoft ACPI-Compliant System



<b>IRQ</b>	<b>Assignment</b>
IRQ 276	Microsoft ACPI-Compliant System
IRQ 277	Microsoft ACPI-Compliant System
IRQ 278	Microsoft ACPI-Compliant System
IRQ 279	Microsoft ACPI-Compliant System
IRQ 280	Microsoft ACPI-Compliant System
IRQ 281	Microsoft ACPI-Compliant System
IRQ 282	Microsoft ACPI-Compliant System
IRQ 283	Microsoft ACPI-Compliant System
IRQ 284	Microsoft ACPI-Compliant System
IRQ 285	Microsoft ACPI-Compliant System
IRQ 286	Microsoft ACPI-Compliant System
IRQ 287	Microsoft ACPI-Compliant System
IRQ 288	Microsoft ACPI-Compliant System
IRQ 289	Microsoft ACPI-Compliant System
IRQ 290	Microsoft ACPI-Compliant System
IRQ 291	Microsoft ACPI-Compliant System
IRQ 292	Microsoft ACPI-Compliant System
IRQ 293	Microsoft ACPI-Compliant System
IRQ 294	Microsoft ACPI-Compliant System
IRQ 295	Microsoft ACPI-Compliant System
IRQ 296	Microsoft ACPI-Compliant System
IRQ 297	Microsoft ACPI-Compliant System
IRQ 298	Microsoft ACPI-Compliant System
IRQ 299	Microsoft ACPI-Compliant System
IRQ 300	Microsoft ACPI-Compliant System
IRQ 301	Microsoft ACPI-Compliant System
IRQ 302	Microsoft ACPI-Compliant System
IRQ 303	Microsoft ACPI-Compliant System
IRQ 304	Microsoft ACPI-Compliant System
IRQ 305	Microsoft ACPI-Compliant System
IRQ 306	Microsoft ACPI-Compliant System
IRQ 307	Microsoft ACPI-Compliant System
IRQ 308	Microsoft ACPI-Compliant System
IRQ 309	Microsoft ACPI-Compliant System
IRQ 310	Microsoft ACPI-Compliant System

<b>IRQ</b>	<b>Assignment</b>
IRQ 311	Microsoft ACPI-Compliant System
IRQ 312	Microsoft ACPI-Compliant System
IRQ 313	Microsoft ACPI-Compliant System
IRQ 314	Microsoft ACPI-Compliant System
IRQ 315	Microsoft ACPI-Compliant System
IRQ 316	Microsoft ACPI-Compliant System
IRQ 317	Microsoft ACPI-Compliant System
IRQ 318	Microsoft ACPI-Compliant System
IRQ 319	Microsoft ACPI-Compliant System
IRQ 320	Microsoft ACPI-Compliant System
IRQ 321	Microsoft ACPI-Compliant System
IRQ 322	Microsoft ACPI-Compliant System
IRQ 323	Microsoft ACPI-Compliant System
IRQ 324	Microsoft ACPI-Compliant System
IRQ 325	Microsoft ACPI-Compliant System
IRQ 326	Microsoft ACPI-Compliant System
IRQ 327	Microsoft ACPI-Compliant System
IRQ 328	Microsoft ACPI-Compliant System
IRQ 329	Microsoft ACPI-Compliant System
IRQ 330	Microsoft ACPI-Compliant System
IRQ 331	Microsoft ACPI-Compliant System
IRQ 332	Microsoft ACPI-Compliant System
IRQ 333	Microsoft ACPI-Compliant System
IRQ 334	Microsoft ACPI-Compliant System
IRQ 335	Microsoft ACPI-Compliant System
IRQ 336	Microsoft ACPI-Compliant System
IRQ 337	Microsoft ACPI-Compliant System
IRQ 338	Microsoft ACPI-Compliant System
IRQ 339	Microsoft ACPI-Compliant System
IRQ 340	Microsoft ACPI-Compliant System
IRQ 341	Microsoft ACPI-Compliant System
IRQ 342	Microsoft ACPI-Compliant System
IRQ 343	Microsoft ACPI-Compliant System
IRQ 344	Microsoft ACPI-Compliant System
IRQ 345	Microsoft ACPI-Compliant System

<b>IRQ</b>	<b>Assignment</b>
IRQ 346	Microsoft ACPI-Compliant System
IRQ 347	Microsoft ACPI-Compliant System
IRQ 348	Microsoft ACPI-Compliant System
IRQ 349	Microsoft ACPI-Compliant System
IRQ 350	Microsoft ACPI-Compliant System
IRQ 351	Microsoft ACPI-Compliant System
IRQ 352	Microsoft ACPI-Compliant System
IRQ 353	Microsoft ACPI-Compliant System
IRQ 354	Microsoft ACPI-Compliant System
IRQ 355	Microsoft ACPI-Compliant System
IRQ 356	Microsoft ACPI-Compliant System
IRQ 357	Microsoft ACPI-Compliant System
IRQ 358	Microsoft ACPI-Compliant System
IRQ 359	Microsoft ACPI-Compliant System
IRQ 360	Microsoft ACPI-Compliant System
IRQ 361	Microsoft ACPI-Compliant System
IRQ 362	Microsoft ACPI-Compliant System
IRQ 363	Microsoft ACPI-Compliant System
IRQ 364	Microsoft ACPI-Compliant System
IRQ 365	Microsoft ACPI-Compliant System
IRQ 366	Microsoft ACPI-Compliant System
IRQ 367	Microsoft ACPI-Compliant System
IRQ 368	Microsoft ACPI-Compliant System
IRQ 369	Microsoft ACPI-Compliant System
IRQ 370	Microsoft ACPI-Compliant System
IRQ 371	Microsoft ACPI-Compliant System
IRQ 372	Microsoft ACPI-Compliant System
IRQ 373	Microsoft ACPI-Compliant System
IRQ 374	Microsoft ACPI-Compliant System
IRQ 375	Microsoft ACPI-Compliant System
IRQ 376	Microsoft ACPI-Compliant System
IRQ 377	Microsoft ACPI-Compliant System
IRQ 378	Microsoft ACPI-Compliant System
IRQ 379	Microsoft ACPI-Compliant System
IRQ 380	Microsoft ACPI-Compliant System

<b>IRQ</b>	<b>Assignment</b>
IRQ 381	Microsoft ACPI-Compliant System
IRQ 382	Microsoft ACPI-Compliant System
IRQ 383	Microsoft ACPI-Compliant System
IRQ 384	Microsoft ACPI-Compliant System
IRQ 385	Microsoft ACPI-Compliant System
IRQ 386	Microsoft ACPI-Compliant System
IRQ 387	Microsoft ACPI-Compliant System
IRQ 388	Microsoft ACPI-Compliant System
IRQ 389	Microsoft ACPI-Compliant System
IRQ 390	Microsoft ACPI-Compliant System
IRQ 391	Microsoft ACPI-Compliant System
IRQ 392	Microsoft ACPI-Compliant System
IRQ 393	Microsoft ACPI-Compliant System
IRQ 394	Microsoft ACPI-Compliant System
IRQ 395	Microsoft ACPI-Compliant System
IRQ 396	Microsoft ACPI-Compliant System
IRQ 397	Microsoft ACPI-Compliant System
IRQ 398	Microsoft ACPI-Compliant System
IRQ 399	Microsoft ACPI-Compliant System
IRQ 400	Microsoft ACPI-Compliant System
IRQ 401	Microsoft ACPI-Compliant System
IRQ 402	Microsoft ACPI-Compliant System
IRQ 403	Microsoft ACPI-Compliant System
IRQ 404	Microsoft ACPI-Compliant System
IRQ 405	Microsoft ACPI-Compliant System
IRQ 406	Microsoft ACPI-Compliant System
IRQ 407	Microsoft ACPI-Compliant System
IRQ 408	Microsoft ACPI-Compliant System
IRQ 409	Microsoft ACPI-Compliant System
IRQ 410	Microsoft ACPI-Compliant System
IRQ 411	Microsoft ACPI-Compliant System
IRQ 412	Microsoft ACPI-Compliant System
IRQ 413	Microsoft ACPI-Compliant System
IRQ 414	Microsoft ACPI-Compliant System
IRQ 415	Microsoft ACPI-Compliant System

<b>IRQ</b>	<b>Assignment</b>
IRQ 416	Microsoft ACPI-Compliant System
IRQ 417	Microsoft ACPI-Compliant System
IRQ 418	Microsoft ACPI-Compliant System
IRQ 419	Microsoft ACPI-Compliant System
IRQ 420	Microsoft ACPI-Compliant System
IRQ 421	Microsoft ACPI-Compliant System
IRQ 422	Microsoft ACPI-Compliant System
IRQ 423	Microsoft ACPI-Compliant System
IRQ 424	Microsoft ACPI-Compliant System
IRQ 425	Microsoft ACPI-Compliant System
IRQ 426	Microsoft ACPI-Compliant System
IRQ 427	Microsoft ACPI-Compliant System
IRQ 428	Microsoft ACPI-Compliant System
IRQ 429	Microsoft ACPI-Compliant System
IRQ 430	Microsoft ACPI-Compliant System
IRQ 431	Microsoft ACPI-Compliant System
IRQ 432	Microsoft ACPI-Compliant System
IRQ 433	Microsoft ACPI-Compliant System
IRQ 434	Microsoft ACPI-Compliant System
IRQ 435	Microsoft ACPI-Compliant System
IRQ 436	Microsoft ACPI-Compliant System
IRQ 437	Microsoft ACPI-Compliant System
IRQ 438	Microsoft ACPI-Compliant System
IRQ 439	Microsoft ACPI-Compliant System
IRQ 440	Microsoft ACPI-Compliant System
IRQ 441	Microsoft ACPI-Compliant System
IRQ 442	Microsoft ACPI-Compliant System
IRQ 443	Microsoft ACPI-Compliant System
IRQ 444	Microsoft ACPI-Compliant System
IRQ 445	Microsoft ACPI-Compliant System
IRQ 446	Microsoft ACPI-Compliant System
IRQ 447	Microsoft ACPI-Compliant System
IRQ 448	Microsoft ACPI-Compliant System
IRQ 449	Microsoft ACPI-Compliant System
IRQ 450	Microsoft ACPI-Compliant System

<b>IRQ</b>	<b>Assignment</b>
IRQ 451	Microsoft ACPI-Compliant System
IRQ 452	Microsoft ACPI-Compliant System
IRQ 453	Microsoft ACPI-Compliant System
IRQ 454	Microsoft ACPI-Compliant System
IRQ 455	Microsoft ACPI-Compliant System
IRQ 456	Microsoft ACPI-Compliant System
IRQ 457	Microsoft ACPI-Compliant System
IRQ 458	Microsoft ACPI-Compliant System
IRQ 459	Microsoft ACPI-Compliant System
IRQ 460	Microsoft ACPI-Compliant System
IRQ 461	Microsoft ACPI-Compliant System
IRQ 462	Microsoft ACPI-Compliant System
IRQ 463	Microsoft ACPI-Compliant System
IRQ 464	Microsoft ACPI-Compliant System
IRQ 465	Microsoft ACPI-Compliant System
IRQ 466	Microsoft ACPI-Compliant System
IRQ 467	Microsoft ACPI-Compliant System
IRQ 468	Microsoft ACPI-Compliant System
IRQ 469	Microsoft ACPI-Compliant System
IRQ 470	Microsoft ACPI-Compliant System
IRQ 471	Microsoft ACPI-Compliant System
IRQ 472	Microsoft ACPI-Compliant System
IRQ 473	Microsoft ACPI-Compliant System
IRQ 474	Microsoft ACPI-Compliant System
IRQ 475	Microsoft ACPI-Compliant System
IRQ 476	Microsoft ACPI-Compliant System
IRQ 477	Microsoft ACPI-Compliant System
IRQ 478	Microsoft ACPI-Compliant System
IRQ 479	Microsoft ACPI-Compliant System
IRQ 480	Microsoft ACPI-Compliant System
IRQ 481	Microsoft ACPI-Compliant System
IRQ 482	Microsoft ACPI-Compliant System
IRQ 483	Microsoft ACPI-Compliant System
IRQ 484	Microsoft ACPI-Compliant System
IRQ 485	Microsoft ACPI-Compliant System

<b>IRQ</b>	<b>Assignment</b>
IRQ 486	Microsoft ACPI-Compliant System
IRQ 487	Microsoft ACPI-Compliant System
IRQ 488	Microsoft ACPI-Compliant System
IRQ 489	Microsoft ACPI-Compliant System
IRQ 490	Microsoft ACPI-Compliant System
IRQ 491	Microsoft ACPI-Compliant System
IRQ 492	Microsoft ACPI-Compliant System
IRQ 493	Microsoft ACPI-Compliant System
IRQ 494	Microsoft ACPI-Compliant System
IRQ 495	Microsoft ACPI-Compliant System
IRQ 496	Microsoft ACPI-Compliant System
IRQ 497	Microsoft ACPI-Compliant System
IRQ 498	Microsoft ACPI-Compliant System
IRQ 499	Microsoft ACPI-Compliant System
IRQ 500	Microsoft ACPI-Compliant System
IRQ 501	Microsoft ACPI-Compliant System
IRQ 502	Microsoft ACPI-Compliant System
IRQ 503	Microsoft ACPI-Compliant System
IRQ 504	Microsoft ACPI-Compliant System
IRQ 505	Microsoft ACPI-Compliant System
IRQ 506	Microsoft ACPI-Compliant System
IRQ 507	Microsoft ACPI-Compliant System
IRQ 508	Microsoft ACPI-Compliant System
IRQ 509	Microsoft ACPI-Compliant System
IRQ 510	Microsoft ACPI-Compliant System
IRQ 511	Microsoft ACPI-Compliant System
IRQ 4294967277	Intel(R) I210 Gigabit Network Connection #2
IRQ 4294967278	Intel(R) I210 Gigabit Network Connection #2
IRQ 4294967279	Intel(R) I210 Gigabit Network Connection #2
IRQ 4294967280	Intel(R) I210 Gigabit Network Connection #2
IRQ 4294967281	Intel(R) I210 Gigabit Network Connection #2
IRQ 4294967282	Intel(R) I210 Gigabit Network Connection #2
IRQ 4294967283	Intel(R) I210 Gigabit Network Connection
IRQ 4294967284	Intel(R) I210 Gigabit Network Connection
IRQ 4294967285	Intel(R) I210 Gigabit Network Connection

<b>IRQ</b>	<b>Assignment</b>
IRQ 4294967286	Intel(R) I210 Gigabit Network Connection
IRQ 4294967287	Intel(R) I210 Gigabit Network Connection
IRQ 4294967288	Intel(R) I210 Gigabit Network Connection
IRQ 4294967289	Intel(R) HD Graphics
IRQ 4294967290	Intel(R) Trusted Execution Engine Interface
IRQ 4294967291	Intel(R) USB 3.0 eXtensible Host Controller - 1.0 (Microsoft)
IRQ 4294967292	Standard SATA AHCI Controller
IRQ 4294967293	Intel(R) Celeron(R)/Pentium(R) Processor PCI Express Root Port - 5AD9
IRQ 4294967294	Intel(R) Celeron(R)/Pentium(R) Processor PCI Express Root Port - 5AD8

**Note:** These resource information were gathered using Windows 10.



**I/O MAP**

<b>I/O Map</b>	<b>Assignment</b>
0x00000000-0x0000006F	PCI Express Root Complex
0x00000020-0x00000021	Programmable interrupt controller
0x00000024-0x00000025	Programmable interrupt controller
0x00000028-0x00000029	Programmable interrupt controller
0x0000002C-0x0000002D	Programmable interrupt controller
0x0000002E-0x0000002F	Motherboard resources
0x00000030-0x00000031	Programmable interrupt controller
0x00000034-0x00000035	Programmable interrupt controller
0x00000038-0x00000039	Programmable interrupt controller
0x0000003C-0x0000003D	Programmable interrupt controller
0x00000040-0x00000043	System timer
0x0000004E-0x0000004F	Motherboard resources
0x00000050-0x00000053	System timer
0x00000061-0x00000061	Motherboard resources
0x00000063-0x00000063	Motherboard resources
0x00000065-0x00000065	Motherboard resources
0x00000067-0x00000067	Motherboard resources
0x00000070-0x00000070	Motherboard resources
0x00000070-0x00000070	System CMOS/real time clock
0x00000078-0x000000CF7	PCI Express Root Complex
0x00000080-0x0000008F	Motherboard resources
0x00000092-0x00000092	Motherboard resources
0x000000A0-0x000000A1	Programmable interrupt controller
0x000000A4-0x000000A5	Programmable interrupt controller
0x000000A8-0x000000A9	Programmable interrupt controller
0x000000AC-0x000000AD	Programmable interrupt controller
0x000000B0-0x000000B1	Programmable interrupt controller
0x000000B2-0x000000B3	Motherboard resources
0x000000B4-0x000000B5	Programmable interrupt controller
0x000000B8-0x000000B9	Programmable interrupt controller
0x000000BC-0x000000BD	Programmable interrupt controller
0x000002F8-0x000002FF	Communications Port (COM2)
0x00000400-0x0000047F	Motherboard resources
0x000004D0-0x000004D1	Programmable interrupt controller

<b>I/O Map</b>	<b>Assignment</b>
0x00000500-0x000005FE	Motherboard resources
0x00000600-0x0000061F	Motherboard resources
0x00000680-0x0000069F	Motherboard resources
0x00000A00-0x00000A0F	Motherboard resources
0x00000A10-0x00000A1F	Motherboard resources
0x00000A20-0x00000A2F	Motherboard resources
0x00000D00-0x0000FFFF	PCI Express Root Complex
0x0000164E-0x0000164F	Motherboard resources
0x0000D000-0x0000DFFF	Intel(R) Celeron(R)/Pentium(R) Processor PCI Express Root Port - 5AD9
0x0000E000-0x0000EFFF	Intel(R) Celeron(R)/Pentium(R) Processor PCI Express Root Port - 5AD8
0x0000F000-0x0000F03F	Intel(R) HD Graphics
0x0000F040-0x0000F05F	Intel(R) Celeron(R)/Pentium(R) Processor SMBUS - 5AD4
0x0000F060-0x0000F07F	Standard SATA AHCI Controller
0x0000F080-0x0000F083	Standard SATA AHCI Controller
0x0000F090-0x0000F097	Standard SATA AHCI Controller

## Memory Map

Memory Map	Assignment
0xE0000000-0xEFFFFFFF	Motherboard resources
0xE0000000-0xEFFFFFFF	PCI Express Root Complex
0xFE000000-0xFEFFFFFF	Motherboard resources
0xFED01000-0xFED01FFF	Motherboard resources
0xFED03000-0xFED03FFF	Motherboard resources
0xFED06000-0xFED06FFF	Motherboard resources
0xFED08000-0xFED09FFF	Motherboard resources
0xFED80000-0xFEDBFFFF	Motherboard resources
0xFED1C000-0xFED1CFFF	Motherboard resources
0xFEE00000-0xFEEFFFFFFF	Motherboard resources
0x91212000-0x912120FF	Intel(R) Celeron(R)/Pentium(R) Processor SMBUS - 5AD4
0x91000000-0x910FFFFFFF	Intel(R) Celeron(R)/Pentium(R) Processor PCI Express Root Port - 5AD9
0x91180000-0x911FFFFFFF	Intel(R) I210 Gigabit Network Connection #2
0x9117C000-0x9117FFFF	Intel(R) I210 Gigabit Network Connection #2
0x91080000-0x910FFFFFFF	Intel(R) I210 Gigabit Network Connection
0x9107C000-0x9107FFFF	Intel(R) I210 Gigabit Network Connection
0xFED00000-0xFED003FF	High precision event timer
0x91200000-0x9120FFFF	Intel(R) USB 3.0 eXtensible Host Controller - 1.0 (Microsoft)
0x91100000-0x911FFFFFFF	Intel(R) Celeron(R)/Pentium(R) Processor PCI Express Root Port - 5AD8
0x80000000-0xCFFFFFFF	PCI Express Root Complex
0x80000000-0xCFFFFFFF	Intel(R) HD Graphics
0x91217000-0x91217FFF	Intel(R) Trusted Execution Engine Interface
0x90000000-0x90FFFFFFF	Intel(R) HD Graphics
0x91210000-0x9121FFFF	Standard SATA AHCI Controller
0x91214000-0x913140FF	Standard SATA AHCI Controller

<b>Memory Map</b>	<b>Assignment</b>
0x91213000-0x913137FF	Standard SATA AHCI Controller
0x7B800001-0x7BFFFFFF	PCI Express Root Complex
0x7C000001-0x7FFFFFFF	PCI Express Root Complex

## **Configuring WatchDog Timer**

The I/O port address of the watchdog timer is 2E (hex) and 2F (hex). 2E (hex) is the address port. 2F (hex) is the data port. User must first assign the address of register by writing address value into address port 2E (hex), then write/read data to/from the assigned register through data port 2F (hex).

### **Configuration Sequence**

To program F81964 configuration registers, the following configuration sequence must be followed:

#### **(1) Enter the extended function mode**

To place the chip into the Extended Function Mode, two successive writes of 0x87 must be applied to Extended Function Enable Registers (EFERs, i.e. 2Eh or 4Eh).

#### **(2) Configure the configuration registers**

The chip selects the Logical Device and activates the desired Logical Devices through Extended Function Index Register (EFIR) and Extended Function Data Register (EFDR). The EFIR is located at the same address as the EFER, and the EFDR is located at address (EFIR+1). First, write the Logical Device Number (i.e. 0x07) to the EFIR and then write the number of the desired Logical Device to the EFDR. If accessing the Chip (Global) Control Registers, this step is not required. Secondly, write the address of the desired configuration register within the Logical Device to the EFIR and then write (or read) the desired configuration register through the EFDR.

#### **(3) Exit the extended function mode**

To exit the Extended Function Mode, writing 0xAA to the EFER is required. Once the chip exits the Extended Function Mode, it is in the normal running mode and is ready to enter the configuration mode.

**Code example for watch dog timer**

Enable watchdog timer and set timeout interval to 30 seconds.

```

;----- Enter to extended function mode -----
mov    dx,    2Eh
mov    al,    87h
out    dx,    al
out    dx,    al
;----- Select Logical Device 7 of watchdog timer -----
mov    al,    07h
out    dx,    al
inc    dx
mov    al,    07h
out    dx,    al
;----- Enable Watch dog feature -----
dec    dx
mov    al,    30h
out    dx,    al
inc    dx
mov    al,    01h
out    dx,    al
;----- Set timeout interval as 30seconds and start counting -----
dec    dx
mov    al,    F6h
out    dx,    al
inc    dx
mov    al,    1Eh
out    dx,    al
;----- Enable Watch PME-----
dec    dx
mov    al,    FAh
out    dx,    al
inc    dx
in     al,    dx
or     al,    51h
out    dx,    al
;----- Set second as counting unit -----
dec    dx
mov    al,    F5h
out    dx,    al
inc    dx
in     al,    dx
and   al,    DEh
out    dx,    al
;----- Start the watchdog timer -----
or     al,    20h
out    dx,    al
;----- Exit the extended function mode -----
dec    dx
mov    al,    AAh
out    dx,    al

```

## **Flash BIOS Update**

### **I. Prerequisites**

- 1** Prepare a bootable media (e.g. USB storage device) which can boot the system to EFI Shell.
- 2** Download and save the BIOS file (e.g. S1X10PM1.bin) to the storage device.
- 3** Copy AMI flash utility – AfuEfix64.efi (v5.12.02.2028) into the storage device. The utility and BIOS file should be saved to the same path.
- 4** Make sure the target system can first boot to the EFI shell environment.
  - (1) Connect the bootable USB device
  - (2) Turn on the computer and press <ESC> or <DEL> key during boot to enter BIOS Setup.
  - (3) The system will go into the BIOS setup menu.
  - (4) Select [**Boot**] menu and set USB bootable device as the 1st boot device.
  - (5) Press <F4> key to save the configuration and exit the BIOS setup menu.

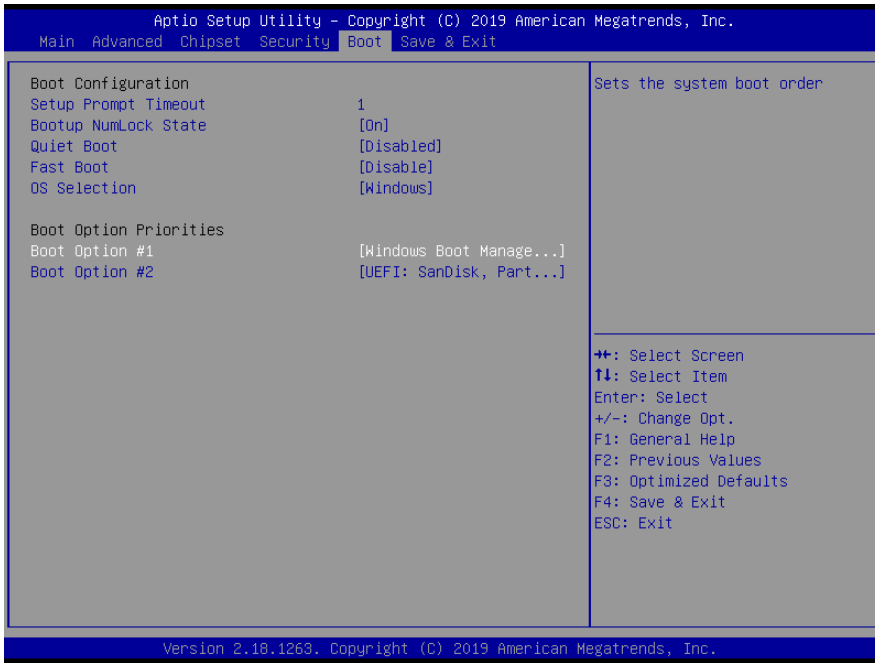

## II. AFUEFIx64 Command for System BIOS Update

AFUEFIx64.efi is the AMI firmware update utility; the command line is shown as below:

**AFUEFIx64 <ROM File Name> [option1] [option2]....**

Users can type “AFUEFIx64 /?” to view the definition of each control option. The recommended options for BIOS ROM update include the following parameters:

- /P:** Program main BIOS image.
- /B:** Program Boot Block.
- /N:** Program NVRAM.
- /X:** Don't check ROM ID.



### III. BIOS Update Procedure

- 1 Use the bootable USB storage to boot up the system into the EFI Shell.
- 2 Type "**AfuEfix64 S151xxxx.bin /p /n /x**" and press Enter to start the flash procedure. (xxxx means the BIOS revision part, e.g. OPM1...)
- 3 During the update procedure, you will see the BIOS update process status and its execution percentage. Beware! Do not turn off the system power or reset your computer if the whole procedure are not complete yet, or it may crash the BIOS ROM and the system will be unable to boot up next time.
- 4 After the BIOS update procedure is completed, the following messages will display:

```
fs0:\> AfuEfix64 S1X10PM1.bin /p /n /x
+-----+
|               AMI Firmware Update Utility v5.12.02.2028               |
|               APL FaultTolerance Mode                               |
| Copyright (c) 1985-2019 American Megatrends International LLC,      |
| All Rights Reserved. Subject to AMI licensing agreement.           |
+-----+
Reading flash ..... done
- FFS checksums ..... ok
- Check Romlayout ..... ok.
- Fault Tolerance Flash Support Enabled.
Fault Tolerant Backup..... done
Erasing AplFt Block ..... done
Updating AplFt Block ..... done
Verifying AplFt Block ..... done
Erasing Main Block ..... done
Updating Main Block ..... done
Verifying Main Block ..... done
Erasing NVRAM Block ..... done
Updating NVRAM Block ..... done
Verifying NVRAM Block ..... done

fs0:\>
```

- 5 Restart the system and boot up with the new BIOS configurations.
- 6 The BIOS Update is completed after the system is restarted.

- 7 Reboot the system and verify if the BIOS version shown on the initialization screen has been updated.

